



EGLO
my light | my style

Поставщик EGLO в
Украине

 **ElectroTorg**

electrotorg.biz.ua



2019/20

TECHNICAL LIGHT SOLUTIONS

TECHNISCHE LICHTLÖSUNGEN
SOLUTIONS D'ÉCLAIRAGE TECHNIQUE

Поставщик EGLO в
Украине

 **ElectroTorg**

electrotorg.biz.ua



Dear customers and business partners,
loyal EGLO friends,

the following catalog is devoted specifically to the EGLO technical light solutions. Some products are very discreet in design but all of them are powerful in light staging.

Whether convenient or creative - create your lighting world with the EGLO technical light solutions.

Geschätzte Kunden und Geschäftspartner, treue EGLO-Freunde,

im folgenden Katalog hat sich EGLO speziell dem technischen Licht gewidmet. Manche Leuchten sind sehr dezent im Auftritt, doch allesamt sind sie stark in der Lichtinszenierung.

Ob zweckmäßig oder kreativ - schaffen Sie sich Ihre Lichtwelt mit den technischen Lichtlösungen von EGLO.

Très chers clients et partenaires, fidèles amis de EGLO,

le catalogue suivant est consacré spécialement à la lumière technique. Certains luminaires sont très discrets dans la conception, mais tous sont forts dans la création de lumière.

Que ce soit pratique ou créatif - créez votre monde d'illumination avec les solutions de lumière technique d'EGLO.

CONTENTS

INHALT
CONTENU



EGLO Connect

LED Panels / LED Paneele / Luminaires lambris LED	14-17
Low Voltage LED Recessed / Niedervolt LED Einbau / Encastrables LED de bas voltage	18-21
Surface Mounted LED / LED Aufbauleuchten / Luminaires LED en saillie	22-25
Bathroom / Badezimmer / Salle de bain	26-27
LED Strips	28-29

EGLO Access

LED Panels / LED Paneele / Luminaires lambris LED	36-39
Low Voltage LED Recessed / Niedervolt LED Einbau / Encastrables LED de bas voltage	40-41
Surface Mounted LED / LED Aufbauleuchten / Luminaires LED en saillie	41
LED Strips	42-43

LED Panel luminaires / LED Paneelleuchten / Luminaires lambris LED

Basic	46-51
frameless / rahmenlos / sans cadre	52-55
with Suspension Frame / mit Schweberahmen / avec bâti flottant	56-61
dimmable / dimmbar / graduable	62-71
RGBW	72-73

**Recessed luminaires high voltage LED
Hochvolt LED Einbauleuchten / Encastrables LED de haute tension**

adjustable / schwenkbar / orientable	78-83
dimmable / dimmbar / graduable	84-93
Bathroom / Badezimmer / Salle de bain	94-99
decorative / dekorativ / décoratif	100-101
Temperdim 2700 - 2300 K	102
Step Lighting / Stufenbeleuchtung / Luminaires d'escalier	103

**Recessed luminaires low voltage LED
Niedervolt LED Einbauleuchten / Encastrables LED de bas voltage**

Standard	106-121
adjustable / schwenkbar / orientable	122-123
dimmable / dimmbar / graduable	124-125
Bathroom / Badezimmer / Salle de bain	126-129
crystal effect / Kristalleffekt / effect cristal	130-131
furniture installation lights / Möbeleinbau leuchten / luminaires de meubles	132-133

**Recessed luminaires GU10 LED
Einbauleuchten GU10 LED / Luminaires encastré GU10 LED**

rigid / starr / fixe	136-137
adjustable / schwenkbar / orientable	138-141
cast aluminium, adjustable / Aluguss, schwenkbar / Fonte d'aluminium, orientable	142-143
Step Dimming	144-145
Excl. Bulb adjustable / Exkl. Leuchtmittel schwenkbar / Orientable Ampoule Excl.	145

**Surface mounted LED luminaires
LED Aufbauleuchten / Luminaires en saillie LED**

Standard	146-163
Bathroom / Badezimmer / Salle de bain	164-165
decorative / dekorativ / décoratif	166-173

LED Strips	174-181
-------------------	---------

Legend & Register	182-191
------------------------------	---------

SMART LIGHT

The success of our EGLO connect Smart Lighting System has encouraged us to continue developing luminaires that offer customers the option of individually adjusting the light colour. Since approx. 70% of our Smart Lighting customers use a remote control in spite of apps and voice control assistants, we laid the technological foundation stone for a new lighting system in 2018 that takes this fact into account.

Our new luminaire concept EGLO Access will have a radio chipset. Radio technology makes it possible to operate up to eight different luminaires as a group by remote control. Functions such as continuous dimming, setting the light colour, a night light function and two freely programmable favourites complete the range of functions.

Der Erfolg unseres Smart Lighting Systems EGLO connect hat uns dabei bestärkt, weiterhin Leuchten zu entwickeln, die den Kunden die Möglichkeit bieten, die Lichtfarbe individuell einstellen zu können. Da ca. 70% unserer Smart Lighting Kunden trotz App und Sprachsteuerungsassistenten hierbei auf eine Fernbedienung zurückgreifen, wurde von uns im Jahr 2018 der technologische Grundstein für eine neues Leuchtensystem gelegt, das dieser Tatsache Rechnung trägt.

Unser neues Leuchtenkonzept EGLO Access wird mit einem Funkchipset ausgestattet sein, bei dem die verwendete Funktechnologie es erlaubt, bis zu acht unterschiedliche Leuchten mittels einer Fernbedienung als Gruppe zu bedienen. Funktionen wie stufenlose Dimmbarkeit, das Einstellen der Lichtfarbe, eine Nachtlichtfunktion sowie zwei frei programmierbare Favoriten runden das Funktionsangebot weiter ab.



Le succès de notre système d'éclairage intelligent EGLO connect nous a encouragés à continuer à développer des luminaires qui offrent aux clients la possibilité de régler individuellement la couleur de lumière. Étant donné qu'environ 70 % de nos clients de l'éclairage intelligent utilisent une télécommande malgré l'appli et les assistants de commande vocale, nous avons posé la première pierre technologique d'un nouveau système d'éclairage en 2018 qui tient compte de ce fait.

Notre nouveau concept de luminaire EGLO Access sera équipé d'un jeu de puces radio dans lequel la technologie radio utilisée permet de commander jusqu'à huit luminaires différents en groupe au moyen d'une télécommande. Des fonctions telles que la graduation progressive, le réglage de la couleur de lumière, une fonction veilleuse et deux favoris librement programmables complètent l'éventail des fonctions.



Light takes a
new direction:
Your direction



OVERVIEW

EGLO CONNECT

 CONNECT REMOTE 14	 SARSINA-C 14	 SARSINA-C 14	 SARSINA-C 15	 SARSINA-C 15	 SALOBRENA-C 16	 SALOBRENA-C 16	 SALOBRENA-C 16
 SALOBRENA-C 17	 SALOBRENA-C 17	 FUEVA-C 18	 FUEVA-C 18	 FUEVA-C 18	 FUEVA-C 19	 FUEVA-C 20	 FUEVA-C 20
 FUEVA-C 20	 FUEVA-C 21	 FUEVA-C 22	 FUEVA-C 22	 FUEVA-C 23	 FUEVA-C 23	 FUEVA-C 24	 FUEVA-C 24
 FUEVA-C 25	 FUEVA-C 25	 FUEVA-C 26	 FUEVA-C 26	 STRIP-C 28	 STRIP-C 28		

EGLO CONNECT
OVERVIEW / ÜBERSICHT / VUE D'ENSEMBLE



3 LET'S GO!!!

2



Remote Control / App
Fernbedienung / App
Télécommande / App

1



Luminaire / Bulb
Leuchte / Leuchtmittel
Luminaire / Ampoules

EASY, SMART & SAFE

EINFACH, INTELLIGENT & SICHER
SIMPLE, INTELLIGENT ET SÛR

If you're looking for easy installation and uncomplicated devices, EGLO connect is the right place for you.

Suchst du leichte Installationen und unkomplizierte Geräte - dann bist du bei EGLO connect genau richtig.

Des installations aisées et des appareils simples – EGLO connect est le bon dispositif pour toi.

Starting is made quick and easy, you only need two components:

Der Einstieg ist schnell und einfach, du benötigst nur zwei Komponenten:

Les premiers pas sont simples et rapides, tu as besoin de deux objets :

- › An EGLO connect luminaire / illuminant
- › An EGLO connect remote control or the free AwoX Smart control App

- › Eine EGLO connect Leuchte / Leuchtmittel
- › Eine EGLO connect Fernbedienung oder die kostenlose AwoX Smart control App

- › Une lampe / ampoule EGLO connect
- › Une télécommande EGLO connect ou l'application gratuite AwoX Smart control

You'll be set to start immediately then!

Schon kann's losgehen!

Prêt à te lancer!

The system's basic advantages are:

Die grundlegenden Vorteile des Systems sind:

Les avantages primordiaux du système sont:



Simple installation

EGLO connect products use Bluetooth technology and do not need any elaborate installations.

Einfache Installation

EGLO connect Produkte verwenden die Bluetooth Technologie und benötigen keine aufwändigen Installationen.

Une installation simple

Les produits EGLO connect emploient la technologie Bluetooth et ne nécessitent pas d'installations complexes.



Smart technology

The EGLO connect items communicate with each other to form a smart, expandible network (MESH technology).

Smarte Technologie

Die EGLO connect Artikel kommunizieren miteinander und bilden ein intelligentes, erweiterbares Netzwerk (MESH-Technologie).

Une technologie intelligente

Les articles EGLO connect communiquent les uns avec les autres et forment un réseau intelligent et extensible (technologie MESH).



Protected network

All EGLO connect products in your home form a closed network and are secured against third-party access.

Geschütztes Netzwerk

Alle EGLO connect Produkte in deinem Zuhause bilden ein geschlossenes Netzwerk und sind vor fremdem Zugriff gesichert.

Un réseau protégé

Tous les produits EGLO connect dans ton foyer forment un réseau fermé et sont ainsi protégés des accès étrangers.

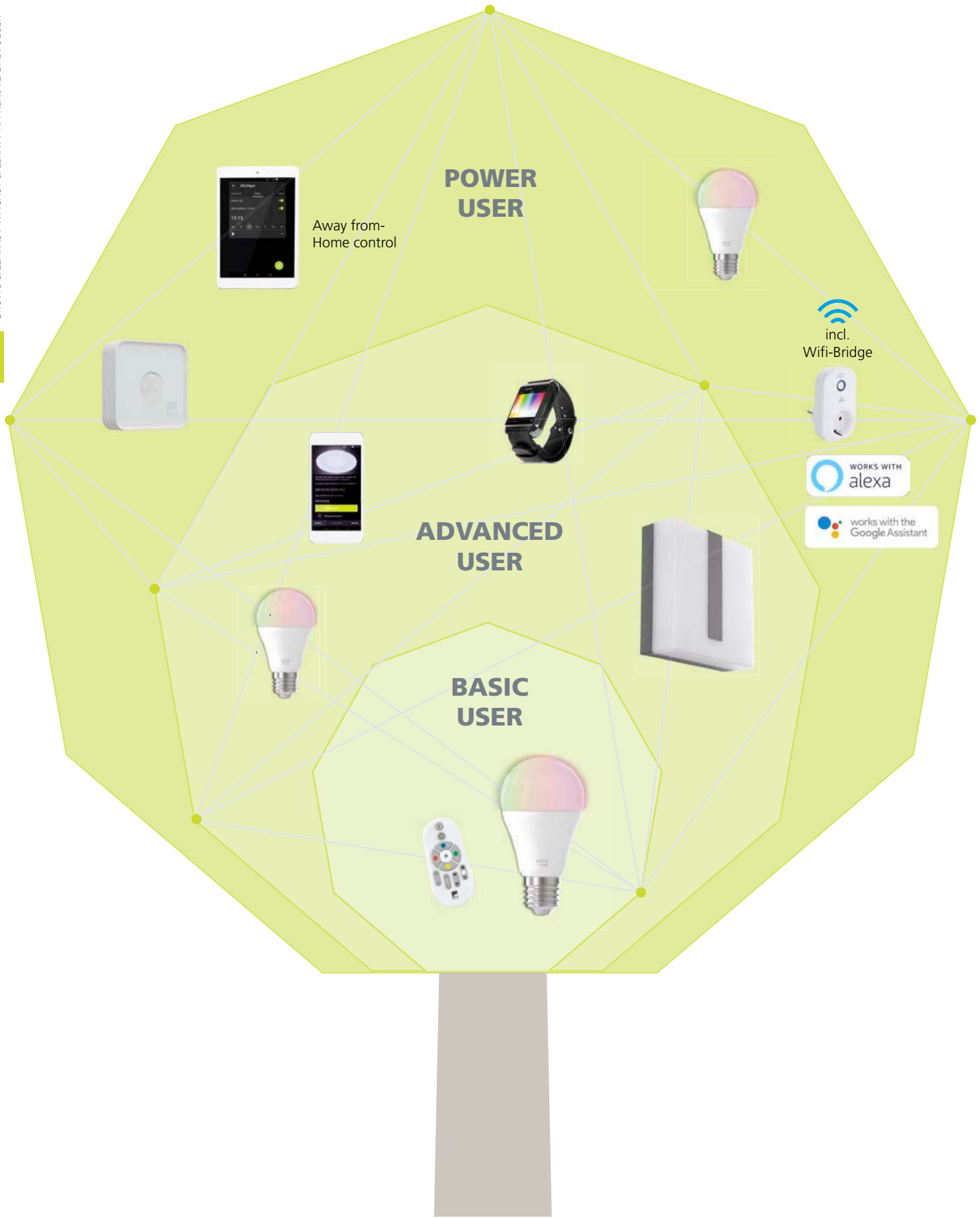

GROWS & LEARNS

WÄCHST & LERNT
APPRENDRE ET ÉVOLUER

EGLO connect grows to match your needs:

BASIC USER:

Use the EGLO connect remote control together with the EGLO connect lamps / luminaires to adjust brightness, colours and mood. These functions are practical, easy to handle and will meet your daily needs.

ADVANCED USER:

Use the App and expand your options: Combine living areas into groups to control lighting and other devices practically and quickly. Add to the experience of a movie night with the matching light scenario.

POWER USER:

Use the full potential of EGLO connect and the PLUG PLUS: Away from-Home control by integration in your WiFi, control by speech commands via Amazon Echo and Google Home, Day & Night function including motion detection and much more – the future of lighting in your home.

EGLO connect wächst mit deinen Bedürfnissen:

BASIC USER:

Du nutzt die EGLO connect Fernbedienung zusammen mit den EGLO connect Leuchtmitteln / Leuchten. Damit stellst du Helligkeit, Farbe und Stimmung ein. Diese Funktionen sind praktisch, einfach zu handhaben und genügen deinen täglichen Bedürfnissen.

ADVANCED USER:

Du nutzt die App und erweiterst deinen Spielraum: Fasse Wohnbereiche zu Gruppen zusammen, um Licht und andere Geräte praktisch und schnell ansteuern zu können. Verstärke das Erlebnis eines Filmabends mit dem passenden Lichtszenario.

POWER USER:

Du nutzt das volle Potential von EGLO connect und dem PLUG PLUS. Away from-Home control durch Intergration in dein W-Lan, Steuerung per Sprachbefehl mit Hilfe von Amazon Echo und Google Home, Day & Night Funktion inklusive Bewegungserkennung und vieles mehr – Lichtzukunft in deinem Heim.

EGLO connect évolue avec tes besoins:

UTILISATEUR DE BASE:

Tu utilises la télécommande EGLO connect conjointement avec les ampoules/luminaires EGLO connect. Tu régles ainsi la luminosité, la couleur et l'ambiance. Ces fonctions sont pratiques, faciles à manier et suffisent à tes besoins au quotidien.

UTILISATEUR AVANCÉ:

Tu utilises l'application et accrois ta marge de manoeuvre : tu rassembles des zones d'habitat en des groupes afin de pouvoir commander la lumière et les autres appareils de manière rapide et pratique. Renforces l'ambiance d'une soirée film par la scénérie lumineuse correspondante.



UTILISATEUR PUISSANT:

Tu utilises l'ensemble du potentiel d'EGLO connect et PLUG PLUS. Un contrôle hors de chez toi par l'intégration dans ton Wi-Fi, un pilotage par commande vocale avec Amazon Echo et Google Home, une fonction jour & nuit avec détection de mouvements et bien d'autres choses - l'avenir de l'éclairage dans ta maison.



FUNCTION & CONTROL

FUNKTION & BEDIENUNG FONCTION ET COMMANDE

Functions Funktionen Fonctions	 Connect Sensor Connect Sensor Capteur Connect	 Remote control Fernbedienung Télécommande	 App control App App App	 CONNECT PLUG	 CONNECT PLUG PLUS  
--------------------------------------	--	--	--	--	---

Basic functions / Grundfunktionen / Fonctions de base

Activation / deactivation Ein- / Ausschalten Allumer / éteindre		•	•	•	•
Motion sensor Bewegungssensor Capteur de mouvements	•				
Light colour regulation Lichtfarben regulieren Réguler les teintes lumineuses		16,7 Mio.	16,7 Mio.		16,7 Mio.
Smooth dimming* Stufenloses Dimmen* Graduation continue*		•	•		•
Voice control Sprachsteuerung Commande par la voix					•

Comfort functions / Komfortfunktionen / Fonctions confort

Pre-set scenarios Voreingestellte Szenarien Scéneries prédéfinies			•		
Saving favourites Favoriten speichern Sauvegarder les favoris		2	4		
Grouping lamps Leuchten gruppieren Regroupement des luminaires			•		
Programming function (on / off) Programmierfunktion (Ein / Aus) Fonction de programmation (marche / arrêt)			•	•	•
Dawn simulation Dämmerungssimulation Simulation de crépuscule			•		
Timer function Timer-Funktion Fonction de minuterie			•	•	•
Day & night function Tag & Nacht-Funktion Fonction jour & nuit	•				
Night light Nachtlicht Veilleuse de nuit			•		
Names & pictures for luminaires Namen & Bilder für Leuchten Noms et photos pour les luminaires			•		
Disco function Diskofunktion Fonction disco			•		
BLE Smart Meter function BLE Smart Meter Funktion BLE Fonction smart meter				•	•

* for EGLO connect luminaires / bulbs only - nur für EGLO connect Leuchten / Leuchtmittel - seulement pour luminaires / ampoules EGLO connect



97959



97958



97961



32732



32732 CONNECT REMOTE

remote control; plastic, white
Fernbedienung; Kunststoff, weiss
télécommande; plastique, blanc

L 110, B 53, H 20



ohne



9 002759 327323



B 53

97958 SARSINA-C

ceiling luminaire; aluminium, white / plastic, white
Deckenleuchte; Alu, weiss / Kunststoff, weiss
plafonnier; aluminium, blanc / plastique, blanc

H 50, Ø 300



LED

16W 2100lm



9 002759 979584



A++



Ø 300

97959 SARSINA-C

ceiling luminaire; aluminium, white / plastic, white
Deckenleuchte; Alu, weiss / Kunststoff, weiss
plafonnier; aluminium, blanc / plastique, blanc

H 50, Ø 450

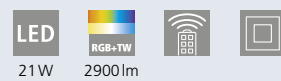

LED

21W 2900lm



9 002759 979591



A++



Ø 450

incl./inkl./inclus



98566



EGLO CONNECT
LED PANELS / LED PANEELE / LUMINAIRES LAMBRIS LED



97958

97961 SARSINA-C

ceiling luminaire; aluminium, white / plastic, white
Deckenleuchte; Alu, weiss / Kunststoff, weiss
plafonnier; aluminium, blanc / plastique, blanc

H 50, Ø 600



34W 4250lm

98566 SARSINA-C

ceiling luminaire; steel, white / plastic, white
Deckenleuchte; Stahl, weiss / Kunststoff, weiss
plafonnier; acier, blanc / plastique, blanc

H 50, Ø 800



45W 5500lm



9 002759 979614



Ø 600



9 002759 985660



Ø 800





96662

LED

97629

LED



96663

LED

96662 SALOBRENA-C

ceiling luminaire; aluminium, white / plastic, white
Deckenleuchte; Alu, weiss / Kunststoff, weiss
plafonnier; aluminium, blanc / plastique, blanc

L 300, B 300, H 50



16W 2000lm

97629 SALOBRENA-C

ceiling luminaire; aluminium, white / plastic, white
Deckenleuchte; Alu, weiss / Kunststoff, weiss
plafonnier; aluminium, blanc / plastique, blanc

L 450, B 450, H 50



21W 2500lm

96663 SALOBRENA-C

ceiling luminaire; aluminium, white / plastic, white
Deckenleuchte; Alu, weiss / Kunststoff, weiss
plafonnier; aluminium, blanc / plastique, blanc

L 595, B 595, H 50



34W 4300lm





96664

LED



incl./inkl./inclus



98089

LED



incl./inkl./inclus

EGLO CONNECT
LED PANELS / LED PANEELE / LUMINAIRES LAMBRIS LED



96664

96664 SALOBRENA-C

ceiling luminaire; aluminium, white / plastic, white
Deckenleuchte; Alu, weiss / Kunststoff, weiss
plafonnier; aluminium, blanc / plastique, blanc

L 1200, B 300, H 50



34W 4300lm

98089 SALOBRENA-C

ceiling luminaire; aluminium, white / plastic, white
Deckenleuchte; Alu, weiss / Kunststoff, weiss
plafonnier; aluminium, blanc / plastique, blanc

L 1195, B 100, H 45



34W 4500lm



9 002759 966645



A++



9 002759 980894



A+

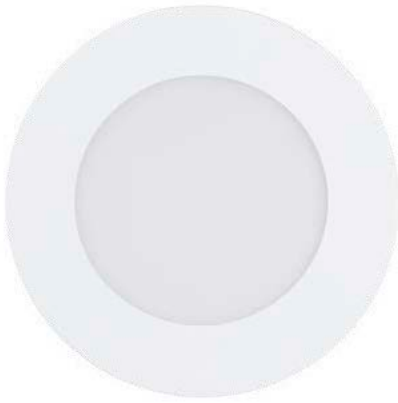

32737

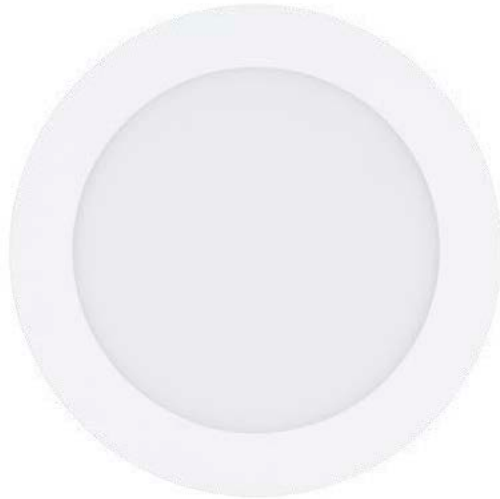

32738

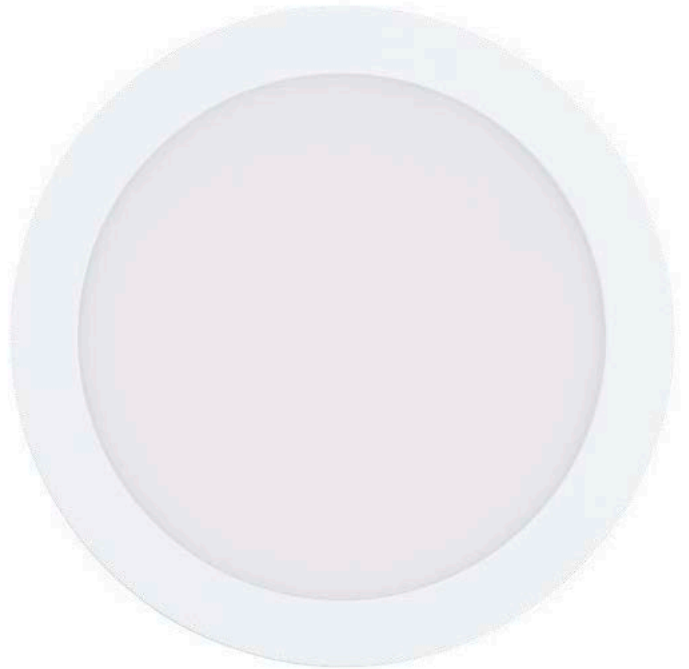

96668



32737 FUEVA-C

recessed luminaire; cast metal, white / plastic, white
Einbauleuchte; Metallguss, weiss / Kunststoff, weiss
luminaire encastrable; fonte métallique, blanc / plastique, blanc

Ø 120, ET 30



5,4W 700lm Ø108

32738 FUEVA-C

recessed luminaire; cast metal, white / plastic, white
Einbauleuchte; Metallguss, weiss / Kunststoff, weiss
luminaire encastrable; fonte métallique, blanc / plastique, blanc

Ø 170, ET 30

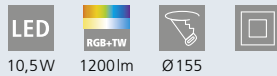

10,5W 1200lm Ø155

96668 FUEVA-C

recessed luminaire; cast metal, white / plastic, white
Einbauleuchte; Metallguss, weiss / Kunststoff, weiss
luminaire encastrable; fonte métallique, blanc / plastique, blanc

Ø 225, ET 30



15,6W 1900lm Ø207



9 002759 327378



Ø 120



9 002759 327385



Ø 170



9 002759 966683



Ø 225

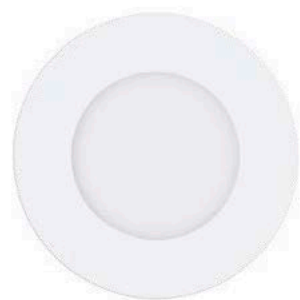
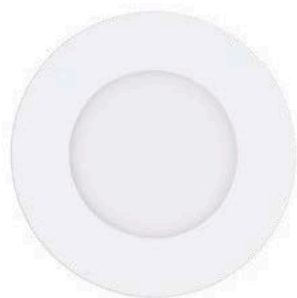
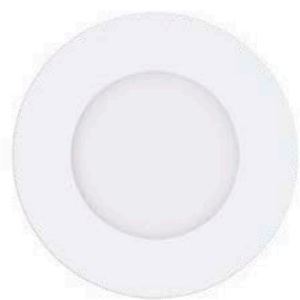

32881



32881

32881 FUEVA-C

recessed luminaire; cast metal, white / plastic, white
Einbauleuchte; Metallguss, weiss / Kunststoff, weiss
luminaire encastrable; fonte métallique, blanc / plastique, blanc

Ø 85, ET 30

3x 3W	3x 360lm	Ø74	





32753



96676



32754



32753 FUEVA-C

recessed luminaire; cast metal, satin nickel / plastic, white
Einbauleuchte; Metallguss, nickel-matt / Kunststoff, weiss
luminaire encastrable; fonte métallique, nickel mat / plastique, blanc

Ø 120, ET 30

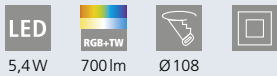

5,4W 700lm Ø108

32754 FUEVA-C

recessed luminaire; cast metal, satin nickel / plastic, white
Einbauleuchte; Metallguss, nickel-matt / Kunststoff, weiss
luminaire encastrable; fonte métallique, nickel mat / plastique, blanc

Ø 170, ET 30

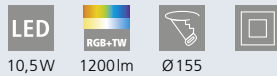

10,5W 1200lm Ø155

96676 FUEVA-C

recessed luminaire; cast metal, satin nickel / plastic, white
Einbauleuchte; Metallguss, nickel-matt / Kunststoff, weiss
luminaire encastrable; fonte métallique, nickel mat / plastique, blanc

Ø 225, ET 30



15,6W 1900lm Ø207



9 002759 327538



Ø 120



9 002759 327545



Ø 170



9 002759 966768



Ø 225



32882



EGLO CONNECT
LOW VOLTAGE LED RECESSED / NIEDERVOLT LED EINBAU / ENCASTRABLES LED DE BAS VOLTAGE



96676

32882 FUEVA-C

recessed luminaire; cast metal, satin nickel / plastic, white
Einbauleuchte; Metallguss, nickel-matt / Kunststoff, weiss
luminaire encastrable; fonte métallique, nickel mat / plastique, blanc

Ø 85, ET 30

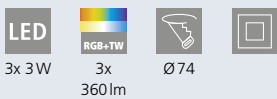

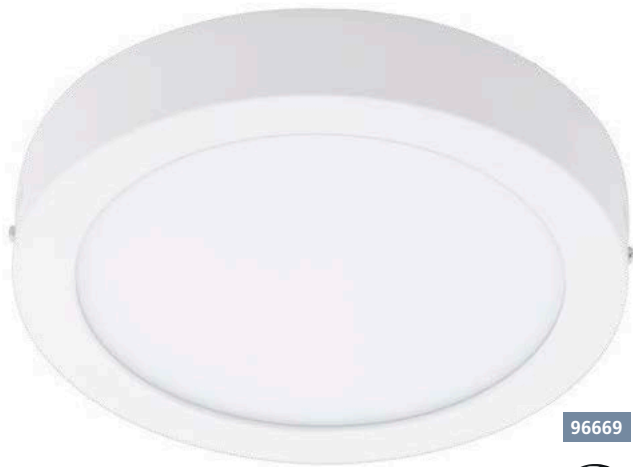

96669



96671



96669 FUEVA-C

surface-mounted luminaire; cast metal, white / plastic, white
Aufbauleuchte; Metallguss, weiss / Kunststoff, weiss
luminaire en saillie; fonte métallique, blanc / plastique, blanc

H 40, Ø 225



15,6W 2000lm

96671 FUEVA-C

surface-mounted luminaire; cast metal, white / plastic, white
Aufbauleuchte; Metallguss, weiss / Kunststoff, weiss
luminaire en saillie; fonte métallique, blanc / plastique, blanc

H 40, Ø 300

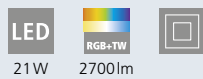

21W 2700lm



9 002759 966690

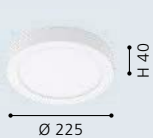

9 002759 966713

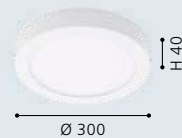



96672



96673



96672 FUEVA-C

surface-mounted luminaire; cast metal, white / plastic, white
Aufbauleuchte; Metallguss, weiss / Kunststoff, weiss
luminaire en saillie; fonte métallique, blanc / plastique, blanc

L 225, B 225, H 40



15,6W 2000lm

96673 FUEVA-C

surface-mounted luminaire; cast metal, white / plastic, white
Aufbauleuchte; Metallguss, weiss / Kunststoff, weiss
luminaire en saillie; fonte métallique, blanc / plastique, blanc

L 300, B 300, H 40

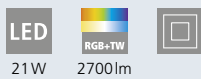

21W 2700lm



9 002759 966720



B 225



9 002759 966737



L 300





96677



96678



96677 FUEVA-C

surface-mounted luminaire; cast metal, satin nickel / plastic, white

Aufbauleuchte; Metallguss, nickel-matt / Kunststoff, weiss
luminaire en saillie; fonte métallique, nickel mat / plastique, blanc

H 40, Ø 225



15,6W 2000lm

96678 FUEVA-C

surface-mounted luminaire; cast metal, satin nickel / plastic, white

Aufbauleuchte; Metallguss, nickel-matt / Kunststoff, weiss
luminaire en saillie; fonte métallique, nickel mat / plastique, blanc

H 40, Ø 300

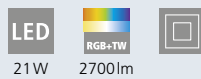

21W 2700lm

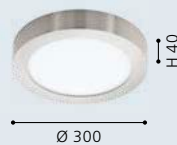
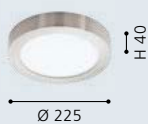



96679



96681



96679 FUEVA-C

surface-mounted luminaire; cast metal, satin nickel / plastic, white

Aufbauleuchte; Metallguss, nickel-matt / Kunststoff, weiss
luminaire en saillie; fonte métallique, nickel mat / plastique, blanc

L 225, B 225, H 40



15,6W 2000lm

96681 FUEVA-C

surface-mounted luminaire; cast metal, satin nickel / plastic, white

Aufbauleuchte; Metallguss, nickel-matt / Kunststoff, weiss
luminaire en saillie; fonte métallique, nickel mat / plastique, blanc

L 300, B 300, H 40

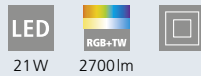

21W 2700lm



9 002759 966799



9 002759 966812

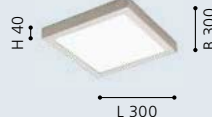



98561



98559



98559 FUEVA-C

surface-mounted luminaire; cast metal, chrome / plastic, white
Aufbauleuchte; Metallguss, chrom / Kunststoff, weiss
luminaire en saillie; fonte métallique, chrome / plastique, blanc

H 40, Ø 300

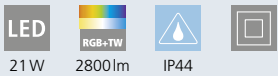

21 W 2800lm IP44

98561 FUEVA-C

surface-mounted luminaire; cast metal, chrome / plastic, white
Aufbauleuchte; Metallguss, chrom / Kunststoff, weiss
luminaire en saillie; fonte métallique, chrome / plastique, blanc

L 300, B 300, H 40

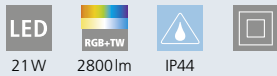

21 W 2800lm IP44



9 002759 985592



9 002759 985615





98559

EGLO CONNECT
BATHROOM / BADEZIMMER / SALLE DE BAIN

IP44



FUEVA-C

These luminaires are protected against splash water.

Diese Leuchten sind gegen Spritzwasser geschützt.

Les luminaires sont protégées contre les éclaboussures d'eau.

IP44



	0	1	2	3
EU	X	X	✓	✓
FR	X	X	X	✓

32741

32733



32741, 32733



1x 1,5 m

1x 1,5 m

32741 STRIP-C

bar / strip luminaire; plastic, white
Leuchtband/-stab; Kunststoff, weiss
bande lumineuse / bâton l; plastique, blanc

L 3000, B 12, H 3

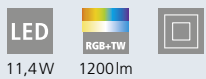

11,4W 1200lm

32733 STRIP-C

bar / strip luminaire; plastic, white
Leuchtband/-stab; Kunststoff, weiss
bande lumineuse / bâton l; plastique, blanc

L 5000, B 12, H 3



19W 2000lm

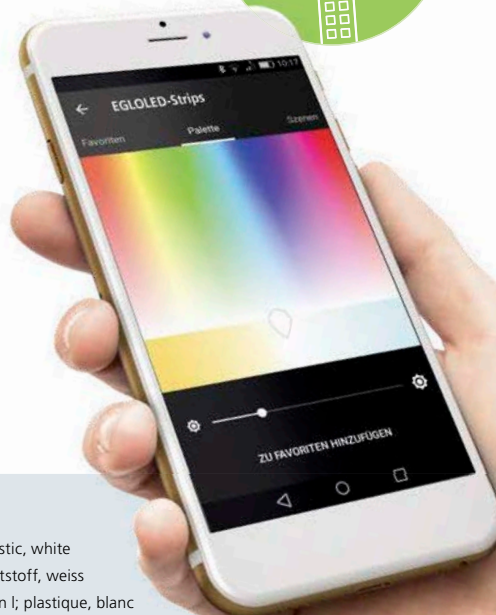

9 002759 327415



L 3000



9 002759 327330



L 5000



EGLO CONNECT
LED STRIPS



EGLO Access

Let **light** follow
your **life**



OVERVIEW

EGLO ACCESS



ACCESS REMOTE
36



SARSINA-A
36



SARSINA-A
36



SARSINA-A
37



SALOBRENA-A
38



SALOBRENA-A
38



SALOBRENA-A
38



SALOBRENA-A
39



SALOBRENA-A
39



FUEVA-A
41



FUEVA-A
41



FUEVA-A
41



LED-STRIPE-A
42



LED-STRIPE-A
42



EGLO ACCESS

EGLO ACCESS
www.eglo.com
CONIÈRE ONES ADAPTE A MOITRE VIE



LET LIGHT FOLLOW YOUR LIFE

DAS LICHT, DAS SICH IHREM LEBEN ANPASST
LA LUMIÈRE QUE S'ADAPTE À VOTRE VIE



EGLO ACCESS
LET LIGHT FOLLOW YOUR LIFE / DAS LICHT, DAS SICH IHREM LEBEN ANPASST / LA
LUMIÈRE QUE S'ADAPTE À VOTRE VIE

Light influences our lives and our work. For example, bright neutral white light improves focus, while warm, dimmed light makes us feel comfortable. You can adjust your EGLO Access luminaires to your requirements or mood.

- › One remote control for different light scenarios
- › 4-ready made settings
- › Tunable white: individually adjustable from warm white to cold white
- › Dimmable with incl. remote control
- › 2 memory functions for individual light

THE SYSTEM'S ADVANTAGES ARE:



Quick and simple installation



One remote control for up to 8 different items and a control distance up to 10 meters.



Light colour from 2700K to 6500K



No internet access necessary

Licht beeinflusst unser Leben und unsere Tätigkeiten. Zum Beispiel fördert helles, neutralweißes Licht die Konzentration, wohingegen warmes, gedimmtes Licht uns ein Gefühl von Behaglichkeit gibt. Je nach Anforderung oder Stimmung können Sie Ihre EGLO Access Leuchte individuell einstellen.

- › Eine Fernbedienung für verschiedene Lichtszenarien
- › 4 fertige Einstellungen
- › Stimmbares Weiß: individuell einstellbar von Warmweiß bis Kaltweiß
- › Dimmbar mit inkludierter Fernbedienung
- › 2 Speicherfunktionen für individuelles Licht

DIE VORTEILE DES SYSTEMS SIND:

Schnelle und einfache Installation

Eine Fernbedienung für bis zu 8 verschiedene Artikel und steuerbar bis zu 10 Meter

Lichtfarbe von 2700K bis 6500K

Kein Internetzugang erforderlich

La lumière influence nos vies et nos activités. Par exemple, une lumière blanche brillante et neutre favorise la concentration, tandis qu'une lumière chaude et atténuée nous procure une sensation de confort. En fonction de vos besoins ou de votre humeur, vous pouvez régler votre éclairage EGLO Access.

- › Une seule télécommande pour différents scénarios d'éclairage
- › 4 réglages prêts à l'emploi
- › Blanc accordable : réglable individuellement du blanc chaud au blanc froid
- › Graduable avec télécommande incluse
- › 2 fonctions mémoire pour un éclairage individuel

LES AVANTAGES DU SYSTÈME SONT :

Installation simple et rapide

Une seule télécommande pour jusqu'à 8 articles différents et contrôlable jusqu'à 10 mètres

Couleur de lumière de 2 700 K à 6 500 K

Aucun accès internet nécessaire

FUNCTIONS

FUNKTIONEN FONCTIONS

Relax with warm light and leave the hustle and bustle of everyday life behind you. Concentrate on your work or dispel fatigue, with neutral white light the energy level is replenished. EGLO Access offers these possibilities and many more. All functions and highlights at a glance:

- › It works with radio frequency technology and allows 360 degree control
- › Controllable up to a distance of 10 meters
- › Up to 8 different items can be connected
- › Easy handling thanks to 4 ready-made settings and 2 memory functions

NIGHT LIGHT

RELAX MODE

WORK MODE

SWITCH OFF AFTER 30 MINUTES

Mit warmem Licht entspannen und die Hektik des Alltages hinter sich lassen. Konzentriert arbeiten oder die Müdigkeit vertreiben, mit neutralweißem Licht wird das Energielevel wieder aufgefüllt. Diese Möglichkeiten und noch viele mehr bietet Ihnen EGLO Access. Alle Funktionen und Highlights auf einem Blick:

- › Es arbeitet mit Funktechnologie und ermöglicht eine 360-Grad-Steuerung
- › Steuerbar bis zu einer Entfernung von 10 Metern
- › Bis zu 8 verschiedene Artikel können miteinander verbunden werden
- › Einfache Handhabung durch 4 vorgefertigte Einstellungen und 2 Speicherfunktionen

NACHTLICHT

ENTSPANNUNGS MODUS

ARBEITSMODUS

AUSSCHALTEN NACH 30 MINUTEN

Lumière chaude pour se détendre et laisser l'agitation quotidienne derrière soi. Travailler de manière concentrée ou chasser la fatigue, avec une lumière blanche neutre, le niveau d'énergie est rétabli. EGLO Access vous offre ces possibilités et bien d'autres encore. Toutes les fonctions et les points forts en un coup d'œil :

- › Il fonctionne avec la technologie de la fréquence radio et permet un contrôle à 360 degrés
- › Contrôlable jusqu'à une distance de 10 mètres
- › Jusqu'à 8 articles différents peuvent être connectés ensemble
- › Manipulation facile grâce à 4 réglages prêts à l'emploi et 2 fonctions mémoire

VEILLEUSE

MODE DE DÉCOMPRESSION

MODE DE TRAVAIL

EXTINCTION APRÈS 30 MINUTES

COLOUR TEMPERATURES SCALE / FARBTEMPERATUREN SKALA / ÉCHELLE DES TEMPÉRATURES DE COULEUR



2700K

3000K

4500K

6500K

WARM WHITE

BRIGHT WHITE

DAY LIGHT

REMOTE CONTROL

FERNBEDIENUNG
TÉLÉCOMMANDE

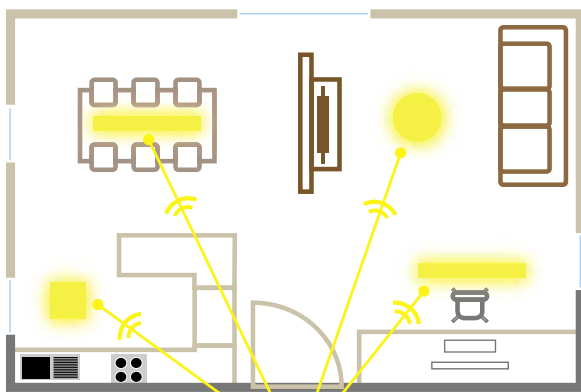
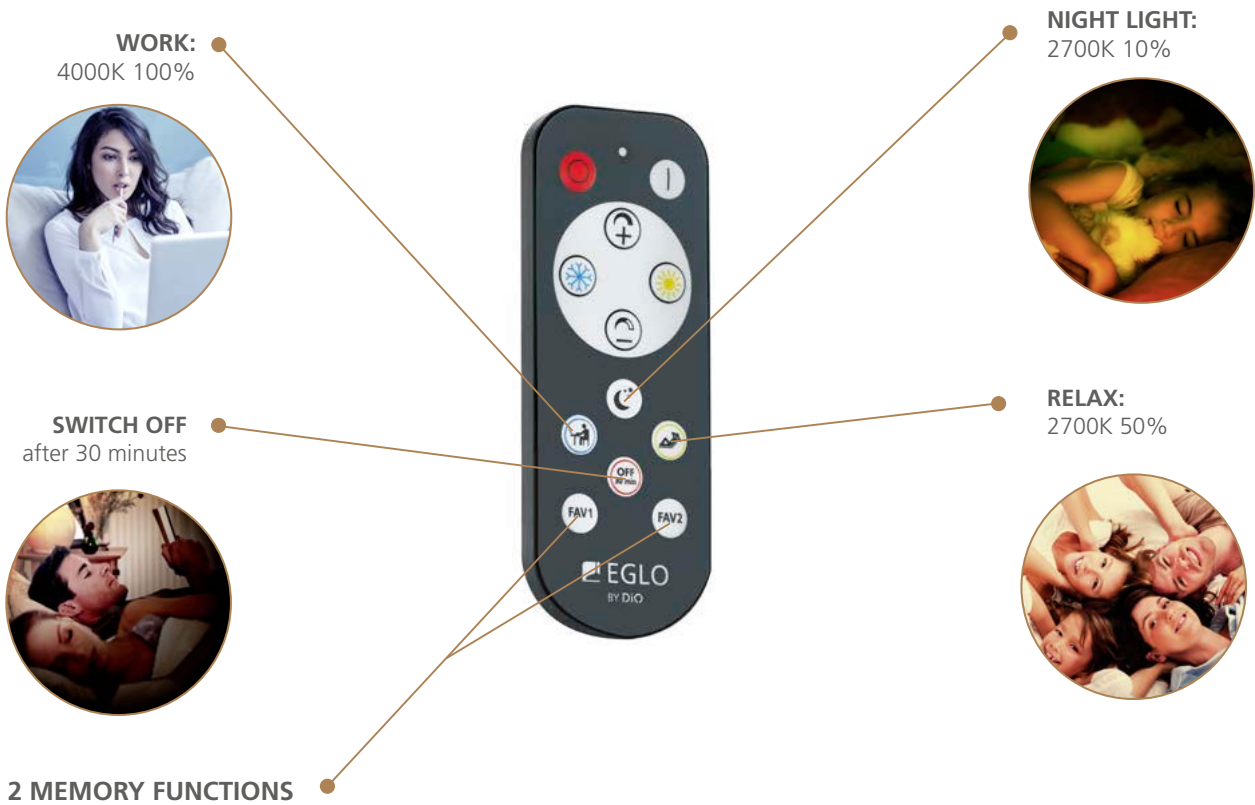

no internet necessary
kein Internet erforderlich
nul besoin d'internet



Control up to 8 EGLO Access luminaires
Bis zu 8 EGLO Access Leuchten steuerbar
Contrôle jusqu'à 8 luminaires EGLO Access



incl./inkl./inclus

98207



33199

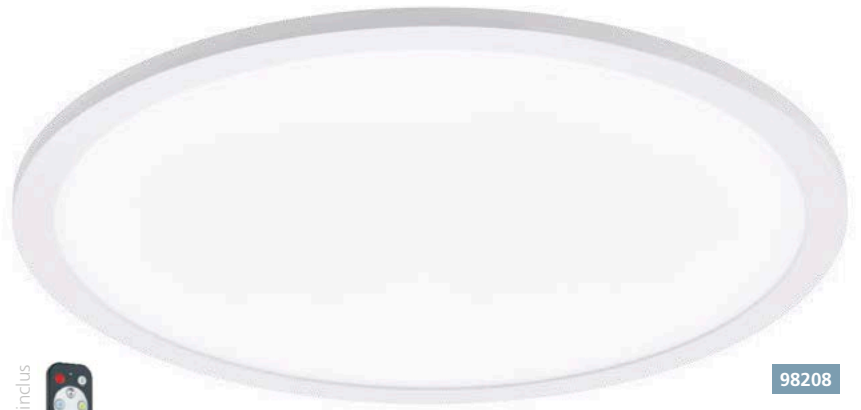

incl./inkl./inclus

98208



33199 ACCESS REMOTE

remote control; plastic, anthracite
Fernbedienung; Kunststoff, anthrazit
télécommande; plastique, anthracite

L 118, B 45



ohne



9 002759 331993



B 45

98207 SARSINA-A

ceiling luminaire; aluminium, white / plastic, white
Deckenleuchte; Alu, weiss / Kunststoff, weiss
plafonnier; aluminium, blanc / plastique, blanc

H 50, Ø 300



LED 14W tunable WHITE 2000lm



9 002759 982072



A+



Ø 300

98208 SARSINA-A

ceiling luminaire; aluminium, white / plastic, white
Deckenleuchte; Alu, weiss / Kunststoff, weiss
plafonnier; aluminium, blanc / plastique, blanc

H 50, Ø 450



LED 19,5W tunable WHITE 2750lm



9 002759 982089



A+



Ø 450

incl./inkl./inclus



98209



EGLO ACCESS
LED PANELS / LED PANEEL / LUMINAIRES LAMBRIS LED



98209

98209 SARSINA-A

ceiling luminaire; aluminium, white / plastic, white
Deckenleuchte; Alu, weiss / Kunststoff, weiss
plafonnier; aluminium, blanc / plastique, blanc

H 50, Ø 600

LED

30W

tunable
WHITE

4000lm



9 002759 982096

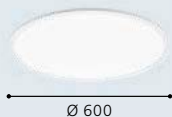



incl./inkl./inclus

98201

LED



incl./inkl./inclus

98297

LED



incl./inkl./inclus

98203

LED

98201 SALOBRENA-A

ceiling luminaire; aluminium, white / plastic, white
Deckenleuchte; Alu, weiss / Kunststoff, weiss
plafonnier; aluminium, blanc / plastique, blanc

L 300, B 300, H 50

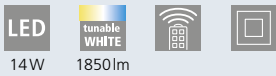

14W 1850lm

98297 SALOBRENA-A

ceiling luminaire; aluminium, white / plastic, white
Deckenleuchte; Alu, weiss / Kunststoff, weiss
plafonnier; aluminium, blanc / plastique, blanc

L 450, B 450, H 50



20W 2600lm

98203 SALOBRENA-A

ceiling luminaire; aluminium, white / plastic, white
Deckenleuchte; Alu, weiss / Kunststoff, weiss
plafonnier; aluminium, blanc / plastique, blanc

L 600, B 600, H 50



30W 4000lm



9 002759 982010



9 002759 982973



9 002759 982034





incl./inkl./inclus



98205

LED



incl./inkl./inclus



98206

LED



EGLO ACCESS
LED PANELS / LED PANEELE / LUMINAIRES LAMBRIS LED

98205 SALOBRENA-A

ceiling luminaire; aluminium, white / plastic, white
Deckenleuchte; Alu, weiss / Kunststoff, weiss
plafonnier; aluminium, blanc / plastique, blanc

L 1200, B 300, H 50



30W 3900lm

98206 SALOBRENA-A

ceiling luminaire; aluminium, white / plastic, white
Deckenleuchte; Alu, weiss / Kunststoff, weiss
plafonnier; aluminium, blanc / plastique, blanc

L 1195, B 100, H 50



30W 3900lm



9 002759 982058



9 002759 982065



A+



A+

EGLO ACCESS
LOW VOLTAGE LED RECESSED / NIEDERVOLT LED EINBAU / ENCASTRABLES LED DE BAS VOLTAGE

98212



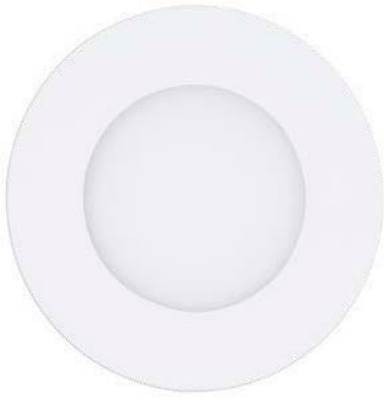

98212 FUEVA-A

recessed luminaire; aluminium, white / plastic, white
Einbauleuchte; Alu, weiss / Kunststoff, weiss
luminaire encastrable; aluminium, blanc / plastique, blanc

Ø 120, ET 30



98292 FUEVA-A

surface-mounted luminaire; aluminium, white / plastic, white
Aufbauleuchte; Alu, weiss / Kunststoff, weiss
luminaire en saillie; aluminium, blanc / plastique, blanc

H 30, Ø 225



98293 FUEVA-A

surface-mounted luminaire; aluminium, white / plastic, white
Aufbauleuchte; Alu, weiss / Kunststoff, weiss
luminaire en saillie; aluminium, blanc / plastique, blanc

H 30, Ø 300



9 002759 982126



Ø 120



9 002759 982928



Ø 225



9 002759 982935



Ø 300

98296

98295



32741, 32733

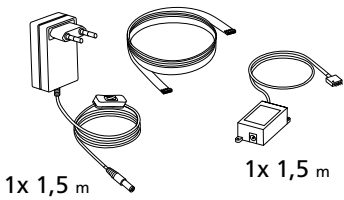

1x 1,5 m

1x 1,5 m

98295, 98296

These articles include a remote control.

Bei diesen Artikeln ist eine Fernbedienung inkludiert.

Ces articles comprennent une télécommande.



98295 LED-STRIPE-A

bar / strip luminaire; plastic, white
Leuchtband/-stab; Kunststoff, weiss
bande lumineuse / bâton l; plastique, blanc

L 2000, B 10, H 3



9W

950lm

98296 LED-STRIPE-A

bar / strip luminaire; plastic, white
Leuchtband/-stab; Kunststoff, weiss
bande lumineuse / bâton l; plastique, blanc

L 5000, B 10, H 3



17W

1800lm

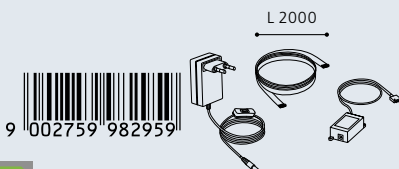

9 002759 982959

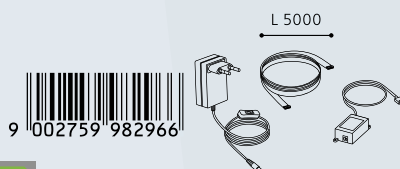

9 002759 982966





98296

RECESSED & SURFACE MOUNTED LUMINAIRES

EIN- & AUFBAULEUCHTEN

LUMINAIRES ENCASTRÉS & EN SAILLIE

EMPHASIZE THE FEATURES - Discreet in the appearance, perfection in staging. Instead of putting themselves in scene, the Recessed & Surface mounted luminaires are highlighting your living area. They convince with their uncomplicated application and due to the use of LED-plates and LED-illuminants they are power- and cost-saving.

AKZENTE SETZEN - Dezent im Auftreten, perfekt in der Inszenierung. Unsere Ein- und Aufbauleuchten setzen nicht sich selbst, sondern Ihr Zuhause in Szene. Sie überzeugen mit ihrer unkomplizierten Anwendung und sind aufgrund der LED-Platinen und LED-Leuchtmittel strom- und kostensparend.

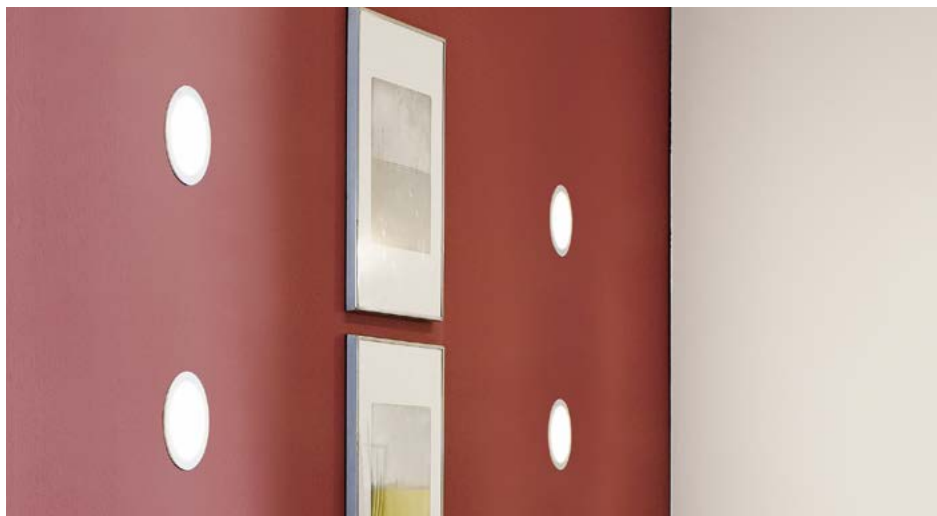

DISCRET EN APPARENCE - parfait dans la mise en scène. Nos luminaires encastrées et en saillie ne mettent pas eux-mêmes en scène, mais votre maison. Ils impressionnent par leur application simple. En plus, ils réduisent les coûts et le besoin d'énergie grâce aux platines et lampes à LED.



5

year warranty
Jahre Garantie
ans de garantie
anni di garanzia
años de garantía
anos de garantía



LED PANEL LUMINAIRES BASIC

LED PANEELLEUCHTEN BASIC
LUMINAIRES LAMBRIS LED BASIC

Advantages

- › Slim design with 6 mounting options
- › Uniform distribution of light - ideal for illuminating spaces and surfaces
- › Low temperature enhances safety
- › Up to 80% power savings compared to incandescent lamps, saves your budget and takes care of the environment

Vorteile

- › Schlanke Bauform mit 6 Montagevarianten
- › Homogene Lichtverteilung – ideal zur Beleuchtung von Räumen und Flächen
- › Geringe Wärmeentwicklung sorgt für mehr Sicherheit
- › Bis zu 80% Stromersparnis gegenüber Glühlampen, schont Ihr Budget und die Umwelt

Avantages

- › Conception mince avec 6 options de montage
- › Distribution uniforme de la lumière - idéal pour l'illumination des espaces et surfaces
- › Faible chaleur améliore la sécurité
- › Jusqu'à 80% d'économies d'énergie par rapport aux lampes à incandescence, réduit votre budget et protège l'environnement



PRODUCTS



96152
48

96154
48

96153
48



96151
49

ACCESSORIES INCLUDED



Zubehör inkludiert
accessoires inclus

OPTIONAL ACCESSORIES



optionales Zubehör
accessoires optionnels

50-51



96153



96152



96154



96152 SALOBRENA 1

grid luminaire; aluminium, white / plastic, white
Rasterleuchte; Alu, weiss / Kunststoff, weiss
luminaire à grille; aluminium, blanc / plastique, blanc

L 300, B 300, H 11



16W 2100lm

96153 SALOBRENA 1

grid luminaire; aluminium, white / plastic, white
Rasterleuchte; Alu, weiss / Kunststoff, weiss
luminaire à grille; aluminium, blanc / plastique, blanc

L 595, B 595, H 11



40W 4300lm

96154 SALOBRENA 1

grid luminaire; aluminium, white / plastic, white
Rasterleuchte; Alu, weiss / Kunststoff, weiss
luminaire à grille; aluminium, blanc / plastique, blanc

L 620, B 620, H 11



40W 4100lm



9 002759 961527



9 002759 961534



9 002759 961541





96151

LED

MOUNTING WITH INCLUDED MATERIAL

MONTAGE MIT INKLUDIERTEM MONTAGEMATERIAL
MONTAGE AVEC MATÉRIEL DE MONTAGE INCLUS



1 GRID LUMINAIRE
RASTERLEUCHTE
LUMINAIRE À GRILLE

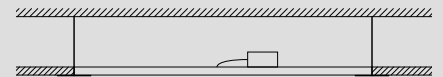

2 RECESSED LUMINAIRE
EINBAULEUCHTE
LUMINAIRE ENCASTRÉE



3 SEMI-RECESSED LUMINAIRE
SEMI-EINBAULEUCHTE
LUMINAIRE SEMI-ENCASTRÉE



4 SURFACE LUMINAIRE
AUFBAULEUCHTE
LUMINAIRE EN SAILLIE

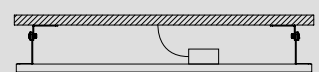

96151 SALOBRENA 1

grid luminaire; aluminium, white / plastic, white
Rasterleuchte; Alu, weiss / Kunststoff, weiss
luminaire à grille; aluminium, blanc / plastique, blanc

L 1200, B 300, H 11



40W 5500lm



9 002759 961510





61489



61489 SALOBRENA 1

accessory; steel, white
Zubehör; Stahl, weiss
accessoire; acier, blanc

L 95, B 95, H 2000



5



9 002759 614898



L 95

B 95

61355 SALOBRENA 1

accessory; steel, chrome
Zubehör; Stahl, chrom
accessoire; acier, chrome

L 900



5



9 002759 613556



L 900

61358 SALOBRENA 1

accessory; steel, white
Zubehör; Stahl, weiss
accessoire; acier, blanc

L 603, B 603, H 50



9 002759 613587



L 603

B 603

61361

61359

61358

OPTIONAL MOUNTING

OPTIONALE MONTAGE
MONTAGE OPTIONNEL



5 PENDANT LUMINAIRE HÄNGELEUCHE LUMINAIRE SUSPENSION

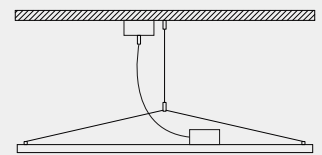

6 FRAME SURFACE LUMINAIRE RAHMEN AUFBAULEUCHE LUMINAIRE EN SAILLIE AVEC BOX

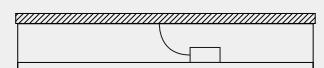

61359 SALOBRENA 1

accessory; steel, white
Zubehör; Stahl, weiss
accessoire; acier, blanc

L 627, B 628, H 50

61361 SALOBRENA 1

accessory; steel, white
Zubehör; Stahl, weiss
accessoire; acier, blanc

L 303, B 1205, H 50



9 002759 613594

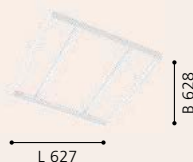

9 002759 613617



5

year warranty
Jahre Garantie
ans de garantie
anni di garanzia
años de garantía
anos de garantía



LED PANEL LUMINAIRES FRAMELESS

LED PANEELLEUCHTEN RAHMENLOS

LUMINAIRES LAMBRIS LED SANS CADRE

Advantages

- › Absolutely frameless! The entire body of the panel is utilized as light source.
- › Ultra-flat design
- › Homogeneous surface lighting
- › Simple and fast installation
- › Elegant suspension frame included
- › Decorative domestic lighting
- › Wall and ceiling lighting

Vorteile

- › Absolut ohne Rahmen! Der gesamte Leuchtkörper dient als Leuchtfläche.
- › Ultraflaches Design
- › Homogene Lichtverteilung
- › Einfache und schnelle Montage
- › Inkl. elegantem Schweberahmen
- › Dekorative Wohnbeleuchtung
- › Wand- und Deckenbeleuchtung

Avantages

- › Absolument sans cadre ! Le corps entier du panneau est utilisé comme source de lumière.
- › Design ultra plat
- › Éclairage de surface homogène
- › Montage simple et rapide
- › Bâti flottant élégant inclus
- › Éclairage domestique décoratif
- › Éclairage mural et plafonnier



PRODUCTS



98475
54



98476
54



98478
55



98477
54



98479
55

ACCESSORIES INCLUDED

Suspension frame for / Schweberahmen für / Bâti flottant pour



98475 white



98476 white



98478 white



98477 white



98475

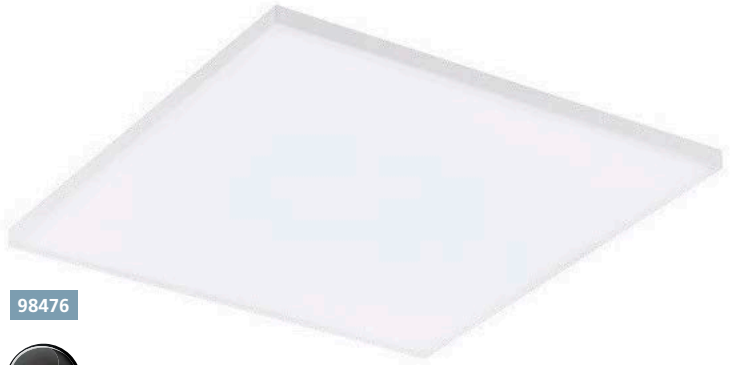

98476



98477



98475 TURCONA

ceiling luminaire; steel, white / plastic, satined
Deckenleuchte; Stahl, weiss / Kunststoff, satiniert
plafonnier; acier, blanc / plastique, satiné

L 300, B 300, H 60



11 W 1300lm

98476 TURCONA

ceiling luminaire; steel, white / plastic, satined
Deckenleuchte; Stahl, weiss / Kunststoff, satiniert
plafonnier; acier, blanc / plastique, satiné

L 450, B 450, H 60



20 W 2400lm

98477 TURCONA

ceiling luminaire; steel, white / plastic, satined
Deckenleuchte; Stahl, weiss / Kunststoff, satiniert
plafonnier; acier, blanc / plastique, satiné

L 595, B 595, H 60



33 W 3800lm



9 002759 984755



L 300



9 002759 984762

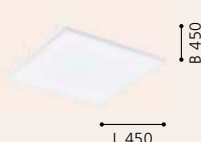

L 450



9 002759 984779



L 595

98479



98478



98478 TURCONA

ceiling luminaire; steel, white / plastic, satined
Deckenleuchte; Stahl, weiss / Kunststoff, satiniert
plafonnier; acier, blanc / plastique, satiné

L 1200, B 300, H 60



33W 3800lm



9 002759 984786

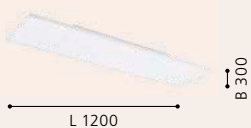

98479 TURCONA

ceiling luminaire; steel, white / plastic, satined
Deckenleuchte; Stahl, weiss / Kunststoff, satiniert
plafonnier; acier, blanc / plastique, satiné

L 1200, B 100, H 60



20W 2600lm



9 002759 984793



5

year warranty
Jahre Garantie
ans de garantie
anni di garanzia
años de garantía
anos de garantía



LED PANEL WITH SUSPENSION FRAME

LED PANEEL MIT SCHWEBERAHMEN

LUMINAIRES LAMBRIS AVEC BÂTI FLOTTANT

Advantages

- › Surface light with shadowless lighting
- › Ultra-flat design
- › Homogeneous surface lighting
- › Simple installation
- › Elegant suspension frame included
- › Also for flush mounting suitable

Vorteile

- › Flächiges Licht mit schattenfreier Ausleuchtung
- › Ultraflaches Design
- › Homogene Flächenausleuchtung
- › Einfache Montage
- › Inkl. elegantem Schweberahmen
- › Auch für flächenbündigen Einbau geeignet

Avantages

- › Éclairage étalé avec éclairage sans ombre
- › Design ultra plat
- › Éclairage de surface homogène
- › Montage simple
- › Bâti flottant élégant inclus
- › Adapté au montage encastré



PRODUCTS

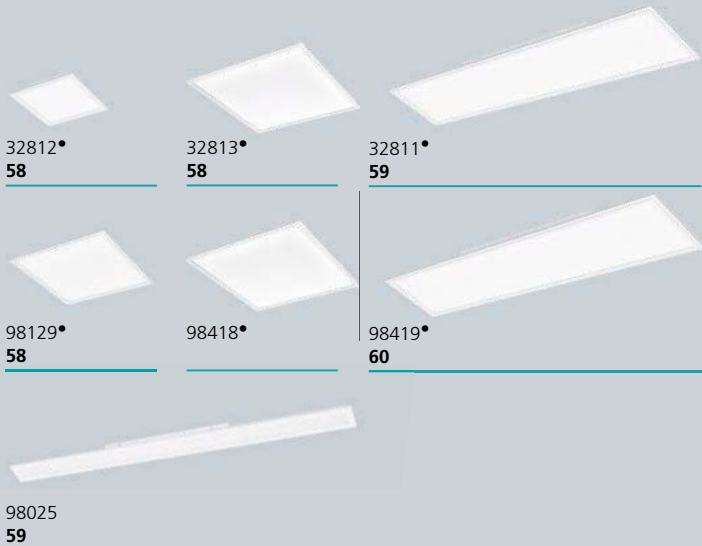

ACCESSORIES INCLUDED

Suspension frame for / Schweberahmen für / Bâti flottant pour





98129



32812



32813



32812 SALOBRENA 1

ceiling luminaire; aluminium, steel, white / plastic, white
Deckenleuchte; Alu, Stahl, weiss / Kunststoff, weiss
plafonnier; aluminium, acier, blanc / plastique, blanc

L 300, B 300, H 50



16W 2100lm

98129 SALOBRENA 1

ceiling luminaire; aluminium, white / plastic, white
Deckenleuchte; Alu, weiss / Kunststoff, weiss
plafonnier; aluminium, blanc / plastique, blanc

L 450, B 450, H 50



21W 2700lm

32813 SALOBRENA 1

ceiling luminaire; aluminium, steel, white / plastic, white
Deckenleuchte; Alu, Stahl, weiss / Kunststoff, weiss
plafonnier; aluminium, acier, blanc / plastique, blanc

L 595, B 595, H 50



40W 4300lm



9 002759 328122



9 002759 981297



9 002759 328139





32811



98025



32812

LED PANEL LUMINAIRES
WITH SUSPENSION FRAME / MIT SCHWEBERAHMEN / AVEC BÂTI FLOTTANT

32811 SALOBRENA 1

ceiling luminaire; aluminium, steel, white / plastic, white
Deckenleuchte; Alu, Stahl, weiss / Kunststoff, weiss
plafonnier; aluminium, acier, blanc / plastique, blanc

L 1200, B 300, H 50



40W 5500lm

98025 SALOBRENA 1

ceiling luminaire; aluminium, white / plastic, white
Deckenleuchte; Alu, weiss / Kunststoff, weiss
plafonnier; aluminium, blanc / plastique, blanc

L 1195, B 100, H 45



40W 4250lm



9 002759 328115



9 002759 980252



L 1200

L 1195



98419



12 m
5 sec. - 15 min.



98418



12 m
5 sec. - 15 min.

98418 SALOBRENA-M

ceiling luminaire; aluminium, white / plastic, white
Deckenleuchte; Alu, weiss / Kunststoff, weiss
plafonnier; aluminium, blanc / plastique, blanc

L 595, B 595, H 50



34W 4600lm

98419 SALOBRENA-M

ceiling luminaire; aluminium, white / plastic, white
Deckenleuchte; Alu, weiss / Kunststoff, weiss
plafonnier; aluminium, blanc / plastique, blanc

L 1195, B 295, H 50



33W 5400lm



9 002759 984182



9 002759 984199





LED PANEL LUMINAIRES
WITH SUSPENSION FRAME / MIT SCHWEBERAHMEN / AVEC BÂTI FLOTTANT

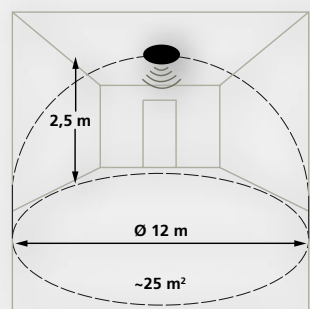

 **time: 5 sec. - 15 min.**

SALOBRENA-M

These luminaires come with an integrated motion sensor. This sensor is mounted invisibly.

Diese Leuchten sind mit einem integrierten Bewegungssensor ausgestattet. Der Sensor ist unsichtbar versteckt.

Ces luminaires viennent avec un capteur de mouvement intégré. Ce capteur est attaché invisiblement.

5

year warranty
Jahre Garantie
ans de garantie
anni di garanzia
años de garantía
anos de garantía



LED PANEL LUMINAIRES DIMMABLE

LED PANEELLEUCHTEN DIMMBAR

LUMINAIRES LAMBRIS LED GRADUABLES

Advantages

- › Slim design with 6 mounting options
- › Dimmable
- › Uniform distribution of light - ideal for illuminating spaces and surfaces
- › Low temperature enhances safety
- › Up to 80% power savings compared to incandescent lamps, saves your budget and takes care of the environment
- › Elegant suspension frame included

Vorteile

- › Schlanke Bauform mit 6 Montagevarianten
- › Dimmbar
- › Homogene Lichtverteilung – ideal zur Beleuchtung von Räumen und Flächen
- › Geringe Wärmeentwicklung sorgt für mehr Sicherheit
- › Bis zu 80% Stromersparnis gegenüber Glühlampen, schont Ihr Budget und die Umwelt
- › Inkl. elegantem Schweberahmen

Avantages

- › Conception mince avec 6 options de montage
- › Graduable
- › Distribution uniforme de la lumière - idéal pour l'illumination des espaces et surfaces
- › Faible chaleur améliore la sécurité
- › Jusqu'à 80% d'économies d'énergie par rapport aux lampes à incandescence, réduit votre budget et protège l'environnement
- › Bâti flottant élégant inclus



PRODUCTS

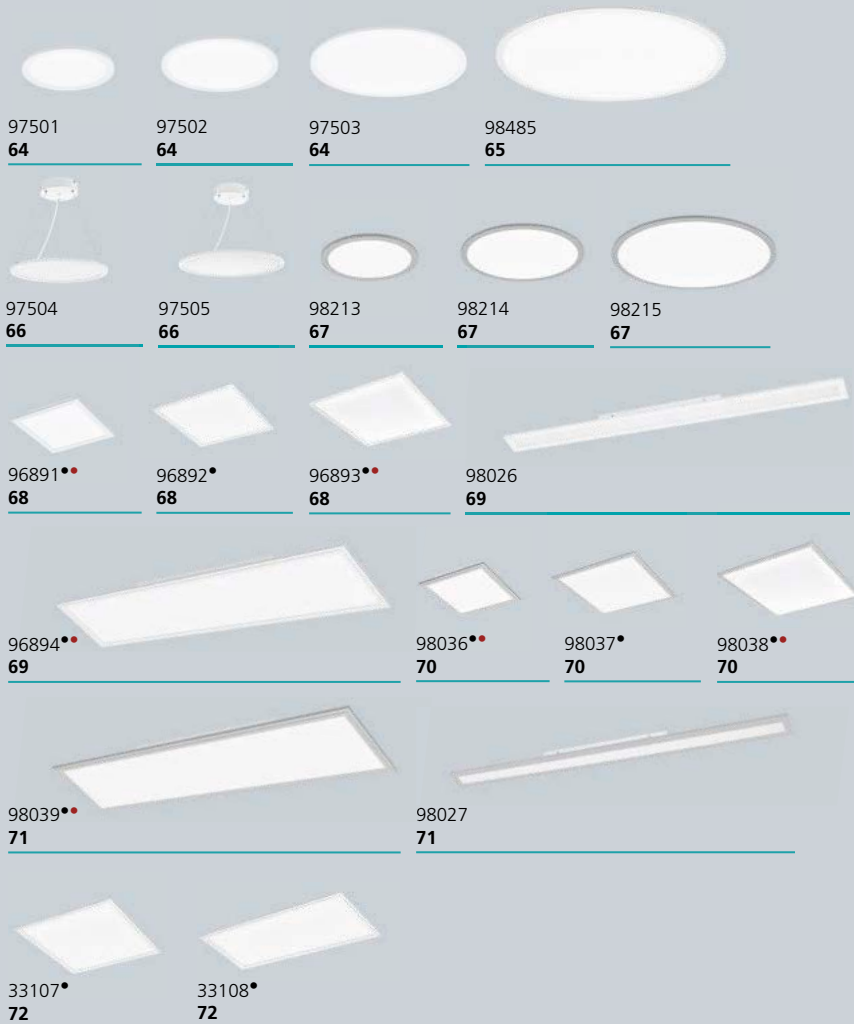

ACCESSORIES INCLUDED

Suspension frame for / Schweberahmen für / Bâti flottant pour



OPTIONAL ACCESSORIES•

optionales Zubehör
accessoires optionnels

50-51



97501

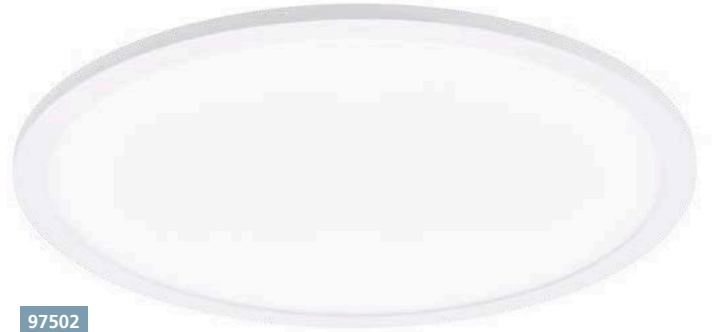

97502



97503



97501 SARSINA

ceiling luminaire; aluminium, white / plastic, white
Deckenleuchte; Alu, weiss / Kunststoff, weiss
plafonnier; aluminium, blanc / plastique, blanc

H 50, Ø 300



17 W 2200 lm

97502 SARSINA

ceiling luminaire; aluminium, white / plastic, white
Deckenleuchte; Alu, weiss / Kunststoff, weiss
plafonnier; aluminium, blanc / plastique, blanc

H 50, Ø 450



28 W 4200 lm

97503 SARSINA

ceiling luminaire; aluminium, white / plastic, white
Deckenleuchte; Alu, weiss / Kunststoff, weiss
plafonnier; aluminium, blanc / plastique, blanc

H 50, Ø 600



36 W 5500 lm



9 002759 975012



9 002759 975029



9 002759 975036



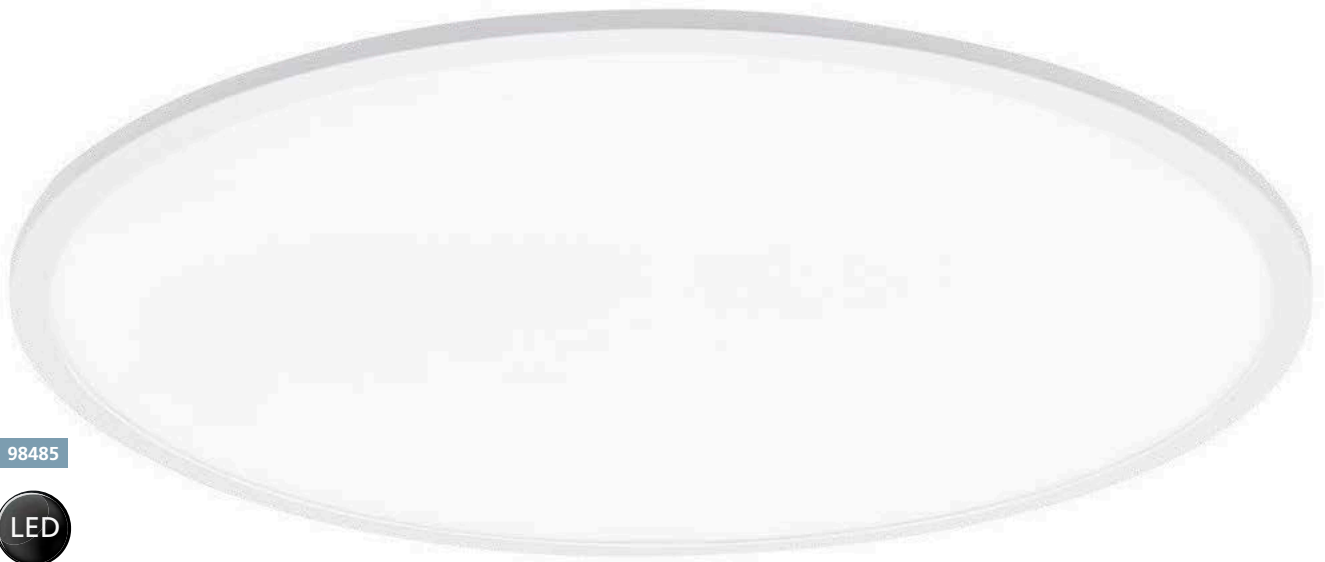

98485



LED PANEL LUMINAIRES
DIMMABLE / DIMMABLE / GRADUABLE



98485

98485 SARSINA

ceiling luminaire; aluminium, white / plastic, white
Deckenleuchte; Alu, weiss / Kunststoff, weiss
plafonnier; aluminium, blanc / plastique, blanc

H 50, Ø 800

LED

36W

neutral
WHITE

5500lm



9 002759 984854



Ø 800

LED PANEL LUMINAIRES
DIMMABLE / DIMMBAR / GRADUABLE



97504



97505



97504 SARSINA

pendant luminaire; aluminium, white / plastic, white
Hängeleuchte; Alu, weiss / Kunststoff, weiss
luminaire en suspension; aluminium, blanc / plastique, blanc

H 1500, Ø 450



28W 4200lm



97505 SARSINA

pendant luminaire; aluminium, white / plastic, white
Hängeleuchte; Alu, weiss / Kunststoff, weiss
luminaire en suspension; aluminium, blanc / plastique, blanc

H 1500, Ø 600



36W 5500lm



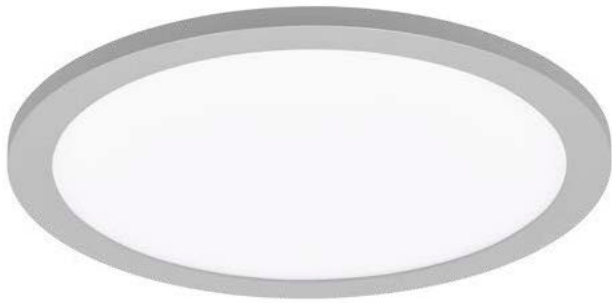

98213

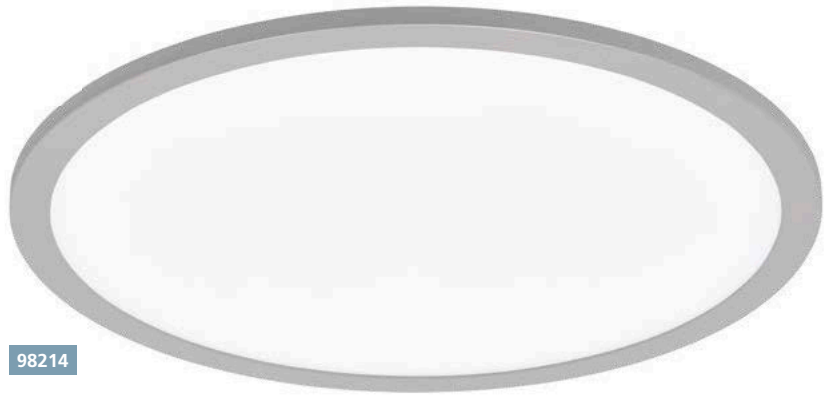

98214

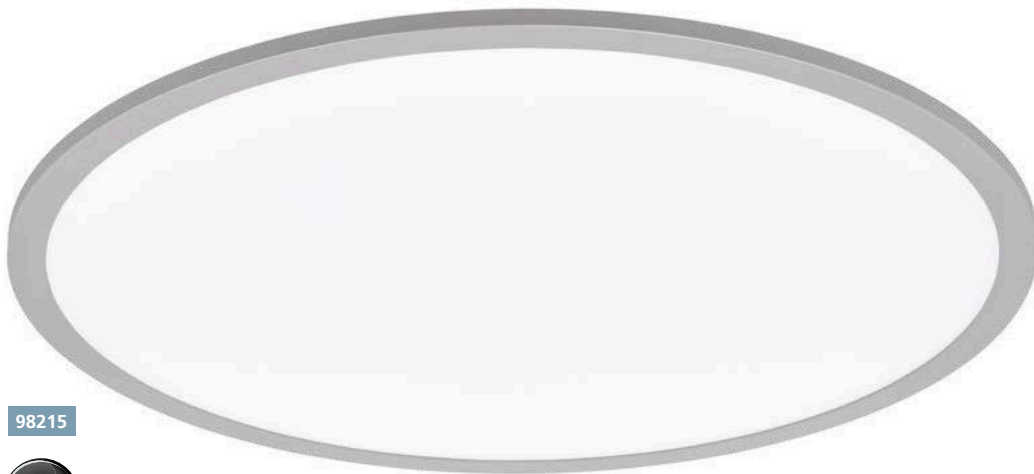

98215



LED PANEL LUMINAIRES
DIMMABLE / DIMMBAR / GRADUABLE



98213 SARSINA

ceiling luminaire; aluminium, grey aluminium / plastic, white
Deckenleuchte; Alu, graualuminium / Kunststoff, weiss
plafonnier; aluminium, gris aluminium / plastique, blanc

H 50, Ø 300



17W 2200lm

98214 SARSINA

ceiling luminaire; aluminium, grey aluminium / plastic, white
Deckenleuchte; Alu, graualuminium / Kunststoff, weiss
plafonnier; aluminium, gris aluminium / plastique, blanc

H 50, Ø 450



28W 4200lm

98215 SARSINA

ceiling luminaire; aluminium, grey aluminium / plastic, white
Deckenleuchte; Alu, graualuminium / Kunststoff, weiss
plafonnier; aluminium, gris aluminium / plastique, blanc

H 50, Ø 600



36W 5500lm



9 002759 982133



Ø 300



9 002759 982140



Ø 450



9 002759 982157



Ø 600



96891



96892



96893



96891 SALOBRENA 2

ceiling luminaire; aluminium, white / plastic, white
Deckenleuchte; Alu, weiss / Kunststoff, weiss
plafonnier; aluminium, blanc / plastique, blanc

L 300, B 300, H 50



16W 2100lm

96892 SALOBRENA 2

ceiling luminaire; aluminium, white / plastic, white
Deckenleuchte; Alu, weiss / Kunststoff, weiss
plafonnier; aluminium, blanc / plastique, blanc

L 450, B 450, H 50



25W 3000lm

96893 SALOBRENA 2

ceiling luminaire; aluminium, white / plastic, white
Deckenleuchte; Alu, weiss / Kunststoff, weiss
plafonnier; aluminium, blanc / plastique, blanc

L 595, B 595, H 50



34W 4200lm



9 002759 968915



9 002759 968922



9 002759 968939





98026



LED

96894



LED

LED PANEL LUMINAIRES
DIMMABLE / DIMMABLE / GRADUABLE



98026 SALOBRENA 2

ceiling luminaire; aluminium, white / plastic, white
Deckenleuchte; Alu, weiss / Kunststoff, weiss
plafonnier; aluminium, blanc / plastique, blanc

L 1195, B 100, H 45



40W 4250lm

96894 SALOBRENA 2

ceiling luminaire; aluminium, white / plastic, white
Deckenleuchte; Alu, weiss / Kunststoff, weiss
plafonnier; aluminium, blanc / plastique, blanc

L 1200, B 300, H 50



32W 5200lm



9 002759 980269



L 1195

B 100



9 002759 968946



L 1200

B 300





98036



98037



98038



98036 SALOBRENA 2

ceiling luminaire; aluminium, grey aluminium / plastic, white
Deckenleuchte; Alu, graualuminium / Kunststoff, weiss
plafonnier; aluminium, gris aluminium / plastique, blanc

L 300, B 300, H 50



16W 2100lm

98037 SALOBRENA 2

ceiling luminaire; aluminium, grey aluminium / plastic, white
Deckenleuchte; Alu, graualuminium / Kunststoff, weiss
plafonnier; aluminium, gris aluminium / plastique, blanc

L 450, B 450, H 50



25W 3000lm

98038 SALOBRENA 2

ceiling luminaire; aluminium, grey aluminium / plastic, white
Deckenleuchte; Alu, graualuminium / Kunststoff, weiss
plafonnier; aluminium, gris aluminium / plastique, blanc

L 595, B 595, H 50



34W 4200lm



9 002759 980368



9 002759 980375



9 002759 980382





98027



98039



LED PANEL LUMINAIRES
DIMMABLE / DIMMABLE / GRADUABLE



98027 SALOBRENA 2

ceiling luminaire; aluminium, grey aluminium / plastic, white
Deckenleuchte; Alu, graualuminium / Kunststoff, weiss
plafonnier; aluminium, gris aluminium / plastique, blanc

L 1195, B 100, H 45



40W 4250lm

98039 SALOBRENA 2

ceiling luminaire; aluminium, grey aluminium / plastic, white
Deckenleuchte; Alu, graualuminium / Kunststoff, weiss
plafonnier; aluminium, gris aluminium / plastique, blanc

L 1200, B 300, H 50



32W 5200lm



9 002759 980276



9 002759 980399

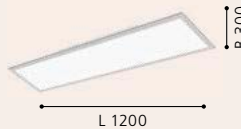



33107



33108



SALOBRENA-RGBW

With the remote control (included in delivery) the following features can be adjusted:

Durch die Fernbedienung (im Lieferumfang enthalten) verfügen diese Leuchten über folgende Funktionen:

Les fonctions différentes peuvent être réglées avec une télécommande incluse avec le luminaire:

- > Color change
- > Change to white light
- > Change to RGB
- > Flash (fast color change)
- > Smooth dimming (slow color change)
10%, 25%, 50%, 100%
- > on/off

33107 SALOBRENA-RGBW

grid luminaire; aluminium, white / plastic, white
Rasterleuchte; Alu, weiss / Kunststoff, weiss
luminaire à grille; aluminium, blanc / plastique, blanc

L 450, B 450, H 11



21 W 2400lm



9 002759 331078



33108 SALOBRENA-RGBW

grid luminaire; aluminium, white / plastic, white
Rasterleuchte; Alu, weiss / Kunststoff, weiss
luminaire à grille; aluminium, blanc / plastique, blanc

L 600, B 300, H 11



21 W 2400lm



9 002759 331085

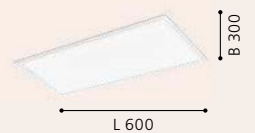



33107

LED PANEL LUMINAIRES
RGBW

5

year warranty
 Jahre Garantie
 ans de garantie
 anni di garanzia
 años de garantía
 anos de garantia



- › Kein Trafo notwendig
- › Anschlußbox für 2-fach Verkabelung
- › Nul besoin d'un transformateur
- › Boîtier de raccordement pour le câblage de 2 fois



25 mm | 35 mm

RECESSED LUMINAIRES HIGH VOLTAGE LED

HOCHVOLT LED EINBAULEUCHTEN

ENCASTRABLES LED DE HAUTE TENSION

Advantages

- › Low mounting depth
- › No transformer necessary - the latest LED high-voltage technology
- › Ideal for lighting of rooms and areas
- › Pleasant warm white light color
- › Low temperature enhances safety
- › Up to 80% power savings compared to incandescent lamps, easy on your budget and the environment
- › Easy and simple wiring by 2-fold junction box - easily expandable

Vorteile

- › Geringe Einbautiefe
- › Kein Trafo mehr notwendig – neueste LED Hochvolt Technologie
- › Ideal zur Beleuchtung von Räumen und Flächen
- › Angenehme warm-weiße Lichtfarbe
- › Geringe Wärmeentwicklung sorgt für mehr Sicherheit
- › Bis zu 80% Stromersparnis gegenüber Glühlampen, schont Ihr Budget und die Umwelt
- › Einfache und sichere Verkabelung durch 2-fach Anschlußbox – unkompliziert erweiterbar

Avantages

- › Faible profondeur de montage
- › Aucun transformateur nécessaire - la dernière technologie à haute tension LED
- › Idéal pour l'éclairage des chambres et des espaces
- › Agréable couleur de lumière blanche chaude
- › Faible chaleur améliore la sécurité
- › Jusqu'à 80% d'économies d'énergie par rapport aux lampes à incandescence, réduit votre budget et protège l'environnement
- › Notre boîte de deux jonctions permet un câblage simple et secure. En plus elle est facilement extensible.

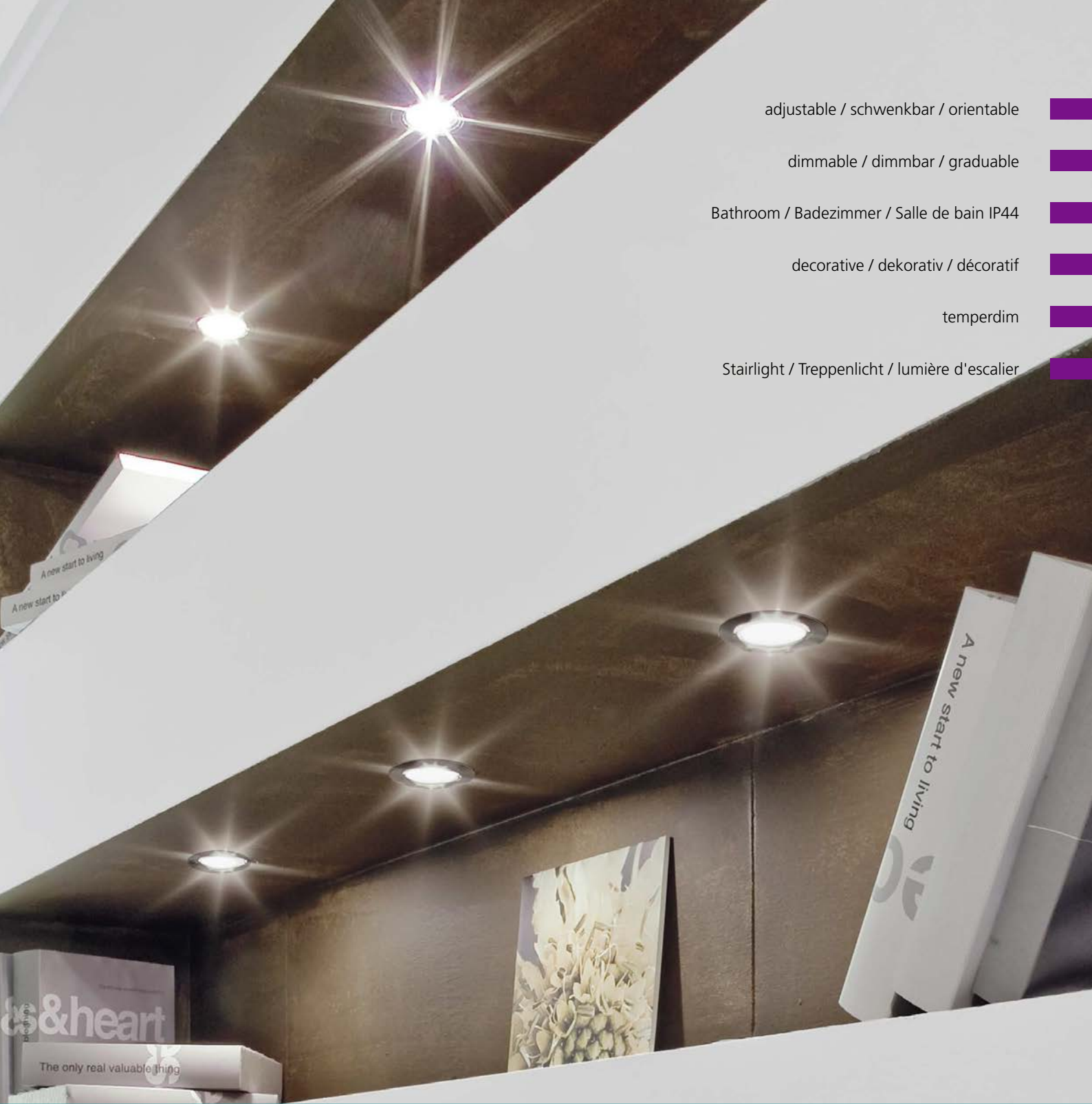

adjustable / schwenkbar / orientable

dimmable / dimmbar / graduable

Bathroom / Badezimmer / Salle de bain IP44

decorative / dekorativ / décoratif

temperdim

Stairlight / Treppenlicht / lumière d'escalier

OVERVIEW



SARTIANO
78



PINEDA
80



PINEDA
83



SALICETO
86



SALICETO
88



SALICETO
90



SALICETO
93



SALABATE
94



SALABATE
94



PINEDA
96



PINEDA
98



MARGO-LED
99



PINEDA 1
100



PINEDA 1
101



RANERA
102



ZARATE
103



Installation Montage / Installation*



1 Simple installation!

Universally usable in walls or ceilings thanks to its small installation depth!

1 Einfache Montage!

Durch die geringe Einbautiefe universell einsetzbar, ob Wand oder Decke!

1 Montage simple !

Emploi universel dû à la faible profondeur de montage, que ce soit au mur ou au plafond !



2 Quick and safe connection!

Easy wiring with the practical connection box! No transformer is needed anymore thanks to state-of-the-art high-voltage technology!



3 Perfect fit!

The integrated holding brackets permit simple installation and guarantee for a precise fit!



4 Flush installation!

The slim build permits fitting installation in any surface!

2 Schnelles und sicheres Anschließen!

Leichtes Verkabeln durch die praktische Anschlussbox! Durch moderne Hochvolt-Technik wird kein Trafo mehr benötigt!

3 Perfekter Halt!

Die integrierten Halteklammern ermöglichen einen einfachen Einbau und sorgen für garantierte Passgenauigkeit!

4 Flächenbündiger Einbau!

Die schlanke Bauform ermöglicht den passenden Einbau bei jeder Fläche!

2 Branchement rapide et sûr !

Câbler simplement avec le boîtier de branchement pratique ! Grâce à la technique de haute tension moderne, plus besoin de transformateur !

3 Maintien parfait !

Les griffes de maintien intégrées permettent un montage simple et assurent un parfait ajustement !

4 Montage à fleur !

La structure fine permet le montage adéquat avec chaque surface !

*The assembly instructions do not apply to the series Sartiano and Zarate / Die Montageanleitung gilt nicht für die Serien Sartiano und Zarate! / Les instructions de montage ne s'appliquent pas à le séries Sartiano e Zarate !



32896



32896 SARTIANO

recessed luminaire; plastic, white
Einbauleuchte; Kunststoff, weiss
luminaire encastrable; plastique, blanc

Ø 90, ET 45



3x 5W 3x 470lm

Ø 73

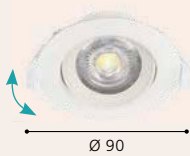



32896

RECESSED LUMINAIRES HIGH VOLTAGE LED
ADJUSTABLE / SCHWENKBAR / ORIENTABLE





95847

LED



95849

LED



95848

LED

95847 PINEDA

recessed luminaire; plastic, white
Einbauleuchte; Kunststoff, weiss
luminaire encastrable; plastique, blanc

Ø 84, ET 40



9 002759 958473



Ø 84

95849 PINEDA

recessed luminaire; plastic, satin nickel
Einbauleuchte; Kunststoff, nickel-matt
luminaire encastrable; plastique, nickel mat

Ø 84, ET 40



9 002759 958497



Ø 84

95848 PINEDA

recessed luminaire; plastic, chrome
Einbauleuchte; Kunststoff, chrom
luminaire encastrable; plastique, chrome

Ø 84, ET 40



9 002759 958480



Ø 84



RECESSED LUMINAIRES HIGH VOLTAGE LED
ADJUSTABLE / SCHWENKBAR / ORIENTABLE



95851 PINEDA

recessed luminaire; plastic, white
Einbauleuchte; Kunststoff, weiss
luminaire encastrable; plastique, blanc

95853 PINEDA

recessed luminaire; plastic, satin nickel
Einbauleuchte; Kunststoff, nickel-matt
luminaire encastrable; plastique, nickel mat

95852 PINEDA

recessed luminaire; plastic, chrome
Einbauleuchte; Kunststoff, chrom
luminaire encastrable; plastique, chrome

Ø 84, ET 40

LED 3x 6W
warm WHITE 3x 500lm



Ø 84, ET 40

LED 3x 6W
warm WHITE 3x 500lm



Ø 84, ET 40

LED 3x 6W
warm WHITE 3x 500lm





95841



95844



95841 PINEDA

recessed luminaire; plastic, white
Einbauleuchte; Kunststoff, weiss
luminaire encastrable; plastique, blanc

95844 PINEDA

recessed luminaire; plastic, white
Einbauleuchte; Kunststoff, weiss
luminaire encastrable; plastique, blanc

L 84, B 84, ET 40

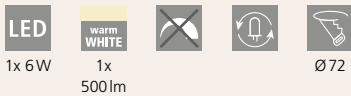

L 84, B 84, ET 40





95843



95846



RECESSED LUMINAIRES HIGH VOLTAGE LED
ADJUSTABLE / SCHWENKBAR / ORIENTABLE



95843 PINEDA

recessed luminaire; plastic, satin nickel
Einbauleuchte; Kunststoff, nickel-matt
luminaire encastrable; plastique, nickel mat

L 84, B 84, ET 40

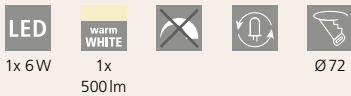

95846 PINEDA

recessed luminaire; plastic, satin nickel
Einbauleuchte; Kunststoff, nickel-matt
luminaire encastrable; plastique, nickel mat

L 84, B 84, ET 40





95854



95856



95855



95854 PINEDA

recessed luminaire; plastic, white
Einbauleuchte; Kunststoff, weiss
luminaire encastrable; plastique, blanc

95856 PINEDA

recessed luminaire; plastic, satin nickel
Einbauleuchte; Kunststoff, nickel-matt
luminaire encastrable; plastique, nickel mat

95855 PINEDA

recessed luminaire; plastic, chrome
Einbauleuchte; Kunststoff, chrom
luminaire encastrable; plastique, chrome

Ø 84, ET 40



9 002759 958541



Ø 84

Ø 84, ET 40



9 002759 958565



Ø 84

Ø 84, ET 40



9 002759 958558



Ø 84



95857



95859



95858



95857 PINEDA
recessed luminaire; plastic, white
Einbauleuchte; Kunststoff, weiss
luminaire encastrable; plastique, blanc

95859 PINEDA
recessed luminaire; plastic, satin nickel
Einbauleuchte; Kunststoff, nickel-matt
luminaire encastrable; plastique, nickel mat

95858 PINEDA
recessed luminaire; plastic, chrome
Einbauleuchte; Kunststoff, chrom
luminaire encastrable; plastique, chrome

Ø 84, ET 40

LED 3x 6W warm WHITE 3x 500lm



A+ RECESSED

Ø 84, ET 40

LED 3x 6W warm WHITE 3x 500lm



A+ RECESSED

Ø 84, ET 40

LED 3x 6W warm WHITE 3x 500lm

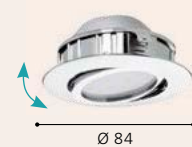

A+ RECESSED



98243



98244



98607



98243 SALICETO

recessed luminaire; aluminium, white
Einbauleuchte; Alu, weiss
luminaire encastrable; aluminium, blanc

H 42, Ø 88



98244 SALICETO

recessed luminaire; aluminium, satin nickel
Einbauleuchte; Alu, nickel-matt
luminaire encastrable; aluminium, nickel mat

H 42, Ø 88



98607 SALICETO

recessed luminaire; aluminium, black
Einbauleuchte; Alu, schwarz
luminaire encastrable; aluminium, noir

H 42, Ø 88



9 002759 982430



Ø 88



9 002759 982447



Ø 88



9 002759 986070



Ø 88





98245



98246



98244

RECESSED LUMINAIRES HIGH VOLTAGE LED
DIMMABLE / DIMMBAR / GRADUABLE



98245 SALICETO

recessed luminaire; aluminium, white
Einbauleuchte; Alu, weiss
luminaire encastrable; aluminium, blanc

H 42, Ø 88



6W

450lm

Ø68

98246 SALICETO

recessed luminaire; aluminium, satin nickel
Einbauleuchte; Alu, nickel-matt
luminaire encastrable; aluminium, nickel mat

H 42, Ø 88



6W

450lm

Ø68



9 002759 982454



Ø 88



9 002759 982461



Ø 88





98472



98473



98471



98471 SALICETO

recessed luminaire; aluminium, white / glass, clear
Einbauleuchte; Alu, weiss / Glas, klar
luminaire encastrable; aluminium, blanc / verre, clair

L 88, B 88, H 42



98472 SALICETO

recessed luminaire; aluminium, satin nickel / glass, clear
Einbauleuchte; Alu, nickel-matt / Glas, klar
luminaire encastrable; aluminium, nickel mat / verre, clair

L 88, B 88, H 42



98473 SALICETO

recessed luminaire; aluminium, white / glass, clear
Einbauleuchte; Alu, weiss / Glas, klar
luminaire encastrable; aluminium, blanc / verre, clair

L 88, B 88, H 42





98474



RECESSED LUMINAIRES HIGH VOLTAGE LED
DIMMABLE / DIMMABLE / GRADUABLE



98474

98474 SALICETO

recessed luminaire; aluminium, satin nickel / glass, clear
Einbauleuchte; Alu, nickel-matt / Glas, klar
luminaire encastrable; aluminium, nickel mat / verre, clair

L 88, B 88, H 42



LED

6W

neutral
WHITE

450lm



Ø68



9 002759 984748





98301



98303



98609



98301 SALICETO

recessed luminaire; aluminium, white
Einbauleuchte; Alu, weiss
luminaire encastrable; aluminium, blanc

98303 SALICETO

recessed luminaire; aluminium, satin nickel
Einbauleuchte; Alu, nickel-matt
luminaire encastrable; aluminium, nickel mat

98609 SALICETO

recessed luminaire; aluminium, black
Einbauleuchte; Alu, schwarz
luminaire encastrable; aluminium, noir

H 42, Ø 88



6W 380lm

Ø68

H 42, Ø 88



6W 380lm

Ø68

H 42, Ø 88



6W 380lm

Ø68



9 002759 983017



Ø 88



9 002759 983031



Ø 88



9 002759 986094



Ø 88





98305



98307

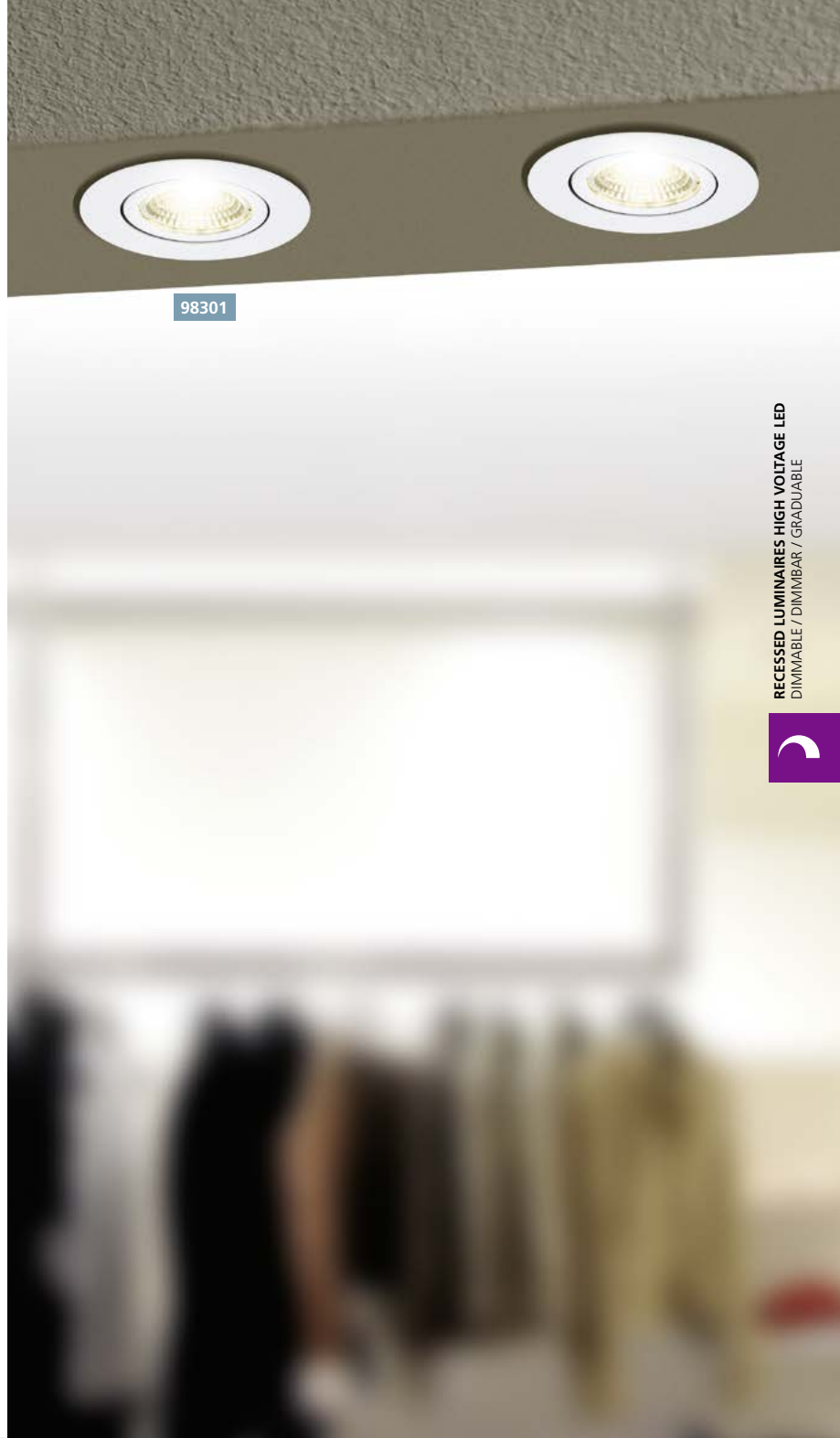

98301

RECESSED LUMINAIRES HIGH VOLTAGE LED
DIMMABLE / DIMMBAR / GRADUABLE



98305 SALICETO

recessed luminaire; aluminium, white
Einbauleuchte; Alu, weiss
luminaire encastrable; aluminium, blanc

H 42, Ø 88



6W

450lm

Ø68

98307 SALICETO

recessed luminaire; aluminium, satin nickel
Einbauleuchte; Alu, nickel-matt
luminaire encastrable; aluminium, nickel mat

H 42, Ø 88



6W

450lm

Ø68



9 002759 983055



Ø 88



9 002759 983079



Ø 88





98302

LED



98304

LED



98611

LED

98302 SALICETO

recessed luminaire; aluminium, white
Einbauleuchte; Alu, weiss
luminaire encastrable; aluminium, blanc

98304 SALICETO

recessed luminaire; aluminium, satin nickel
Einbauleuchte; Alu, nickel-matt
luminaire encastrable; aluminium, nickel mat

98611 SALICETO

recessed luminaire; aluminium, black
Einbauleuchte; Alu, schwarz
luminaire encastrable; aluminium, noir

L 88, B 88, H 42



6W 380lm

Ø68

L 88, B 88, H 42



6W 380lm

Ø68

L 88, B 88, H 42



6W 380lm

Ø68



9 002759 983024



L 88

B 88



9 002759 983048



L 88

B 88



9 002759 986117



L 88

B 88





98306

LED



98308

LED



98308

RECESSED LUMINAIRES HIGH VOLTAGE LED
DIMMABLE / DIMMBAR / GRADUABLE



98306 SALICETO

recessed luminaire; aluminium, white
Einbauleuchte; Alu, weiss
luminaire encastrable; aluminium, blanc

L 88, B 88, H 42



6W 450lm

Ø68

98308 SALICETO

recessed luminaire; aluminium, satin nickel
Einbauleuchte; Alu, nickel-matt
luminaire encastrable; aluminium, nickel mat

L 88, B 88, H 42



6W 450lm

Ø68



9 002759 983062



L 88



9 002759 983086



L 88





98238



98239



98241



98238 SALABATE

recessed luminaire; aluminium, white / glass, clear
Einbauleuchte; Alu, weiss / Glas, klar
luminaire encastrable; aluminium, blanc / verre, clair

H 42, Ø 88



9 002759 982386



98239 SALABATE

recessed luminaire; aluminium, white / glass, clear
Einbauleuchte; Alu, weiss / Glas, klar
luminaire encastrable; aluminium, blanc / verre, clair

L 88, B 88, H 42



9 002759 982393



98241 SALABATE

recessed luminaire; aluminium, white / glass, clear
Einbauleuchte; Alu, weiss / Glas, klar
luminaire encastrable; aluminium, blanc / verre, clair

H 42, Ø 88



9 002759 982416





98242



98241

IP44

98242 SALABATE

recessed luminaire; aluminium, white / glass, clear
Einbauleuchte; Alu, weiss / Glas, klar
luminaire encastrable; aluminium, blanc / verre, clair

L 88, B 88, H 42

- LED
6W
- neutral
WHITE
450lm
-
- Ø68
- 2044





95817



95819



95818



95817 PINEDA

recessed luminaire; plastic, white
Einbauleuchte; Kunststoff, weiss
luminaire encastrable; plastique, blanc

95819 PINEDA

recessed luminaire; plastic, satin nickel
Einbauleuchte; Kunststoff, nickel-matt
luminaire encastrable; plastique, nickel mat

95818 PINEDA

recessed luminaire; plastic, chrome
Einbauleuchte; Kunststoff, chrom
luminaire encastrable; plastique, chrome

Ø 78, ET 35

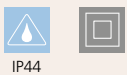

Ø 78, ET 35



Ø 78, ET 35

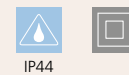



95821

LED



95823

LED



95822

LED

95821 PINEDA

recessed luminaire; plastic, white
Einbauleuchte; Kunststoff, weiss
luminaire encastrable; plastique, blanc

95823 PINEDA

recessed luminaire; plastic, satin nickel
Einbauleuchte; Kunststoff, nickel-matt
luminaire encastrable; plastique, nickel mat

95822 PINEDA

recessed luminaire; plastic, chrome
Einbauleuchte; Kunststoff, chrom
luminaire encastrable; plastique, chrome

Ø 78, ET 35

LED 3x 6W warm WHITE 3x 500lm

 Ø65
 IP44

Ø 78, ET 35

LED 3x 6W warm WHITE 3x 500lm

 Ø65
 IP44

Ø 78, ET 35

LED 3x 6W warm WHITE 3x 500lm

 Ø65
 IP44



A+ RECESSED



A+ RECESSED





95887

LED



95889

LED



95888

LED



PINEDA & MARGO-LED

These luminaires are protected against splash water.

Diese Leuchten sind gegen Spritzwasser geschützt.

Les luminaires sont protégées contre les éclaboussures d'eau.

	0	1	2	3
EU	X	X	✓	✓
FR	X	X	X	✓

95887 PINEDA

recessed luminaire; plastic, white
Einbauleuchte; Kunststoff, weiss
luminaire encastrable; plastique, blanc

95889 PINEDA

recessed luminaire; plastic, satin nickel
Einbauleuchte; Kunststoff, nickel-matt
luminaire encastrable; plastique, nickel mat

95888 PINEDA

recessed luminaire; plastic, chrome
Einbauleuchte; Kunststoff, chrom
luminaire encastrable; plastique, chrome

Ø 102, ET 35

LED warm WHITE 1x 12W 1x 1000lm Ø87 IP44



Ø 102, ET 35

LED warm WHITE 1x 12W 1x 1000lm Ø87 IP44



Ø 102, ET 35

LED warm WHITE 1x 12W 1x 1000lm Ø87 IP44





97428



97426



97427



97428 MARGO-LED

recessed luminaire; cast aluminium, white / plastic, satiné
Einbauleuchte; Aluguss, weiss / Kunststoff, satiniert
luminaire encastrable; fonte d'aluminium, blanc / plastique, satiné

H 10, Ø 82, ET 125



9 002759 974282



97426 MARGO-LED

recessed luminaire; cast aluminium, satin nickel / plastic, satiné
Einbauleuchte; Aluguss, nickel-matt / Kunststoff, satiniert
luminaire encastrable; fonte d'aluminium, nickel mat / plastique, satiné

H 10, Ø 82, ET 125

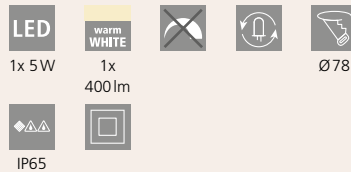

9 002759 974268



97427 MARGO-LED

recessed luminaire; cast aluminium, chrome / plastic, satiné
Einbauleuchte; Aluguss, chrom / Kunststoff, satiniert
luminaire encastrable; fonte d'aluminium, chrome / plastique, satiné

H 10, Ø 82, ET 125



9 002759 974275





95917



95918



95962



95917 PINEDA 1

recessed luminaire; steel, plastic, white / plastic, white
 Einbauleuchte; Stahl, Kunststoff, weiss / Kunststoff, weiss
 luminaire encastrable; acier, plastique, blanc / plastique, blanc

Ø 82, ET 35

LED 1x 6W warm WHITE 1x 500lm
 IP44
 Ø65



9 002759 959173



Ø 82

95918 PINEDA 1

recessed luminaire; steel, plastic, satin nickel / plastic, white
 Einbauleuchte; Stahl, Kunststoff, nickel-matt / Kunststoff, weiss
 luminaire encastrable; acier, plastique, nickel mat / plastique, blanc

Ø 82, ET 35

LED 1x 6W warm WHITE 1x 500lm
 IP44
 Ø65



9 002759 959180



Ø 82

95962 PINEDA 1

recessed luminaire; steel, plastic, chrome / plastic, white
 Einbauleuchte; Stahl, Kunststoff, chrom / Kunststoff, weiss
 luminaire encastrable; acier, plastique, chrome / plastique, blanc

Ø 82, ET 35

LED 1x 6W warm WHITE 1x 500lm
 IP44
 Ø65



9 002759 959623



Ø 82



95932



RECESSED LUMINAIRES HIGH VOLTAGE LED
DECORATIVE / DÉCORATIF / DECORATIF



95932 PINEDA 1

recessed luminaire; steel, plastic, white, satin nickel / plastic, clear, satiné

Einbauleuchte; Stahl, Kunststoff, weiss, nickel-matt / Kunststoff, klar, satiniert

luminaire encastrable; acier, plastique, blanc, nickel mat / plastique, clair, satiné

Ø 145, ET 35

LED

1x 12W

warm
WHITE

1x
1000lm



Ø 90



A+



Ø 145



97028



97027



97028



97027, 97028

The light color of the TemperDIM luminaires gets warmer (2700 - 2300K) when dimming. The LED luminaires are simulating the lighting behavior of conventional GU10 bulbs with the advantage of LED power saving technology.

Die Lichtfarbe der TemperDIM - Leuchten wird beim Dimmen wärmer (2700 - 2300K). Damit simulieren die LED Leuchten das Leuchtverhalten von herkömmlichen GU10 Leuchtmitteln - mit dem Vorteil der Leistungseinsparung durch LED Technologie.

La couleur des luminaires TemperDIM devient plus chaud en graduant (2700 - 2300K). Simulent le comportement de la lumière des lampes GU10 conventionnelles avec l'avantage d'économie d'énergie grâce à la technologie LED.



97027 RANERA

recessed luminaire; aluminium, white / glass, clear
Einbauleuchte; Alu, weiss / Glas, klar
luminaire encastrable; aluminium, blanc / verre, clair

H 30, Ø 85, ET 50



6W 372lm



6W 372lm





96901



96902



RECESSED LUMINAIRES HIGH VOLTAGE LED
STEP LIGHTING / STUFENBELEUCHTUNG / LUMINAIRES D'ESCALIER

96901 ZARATE

recessed luminaire; cast aluminium, white / plastic, white
Einbauleuchte; Aluguss, weiss / Kunststoff, weiss
luminaire encastrable; fonte d'aluminium, blanc / plastique, blanc

L 80, H 80, ET 40



96902 ZARATE

recessed luminaire; cast aluminium, silver / plastic, white
Einbauleuchte; Aluguss, silber / Kunststoff, weiss
luminaire encastrable; fonte d'aluminium, argent / plastique, blanc

L 80, H 80, ET 40

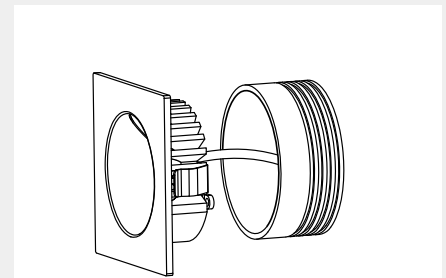

96901 & 96902

including plaster ring
inklusive Einputzring
y compris l'anneau de plâtre

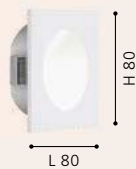

5

year warranty
 Jahre Garantie
 ans de garantie
 anni di garanzia
 años de garantía
 anos de garantia

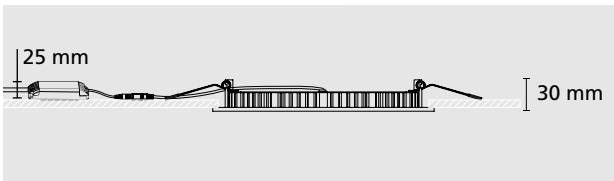
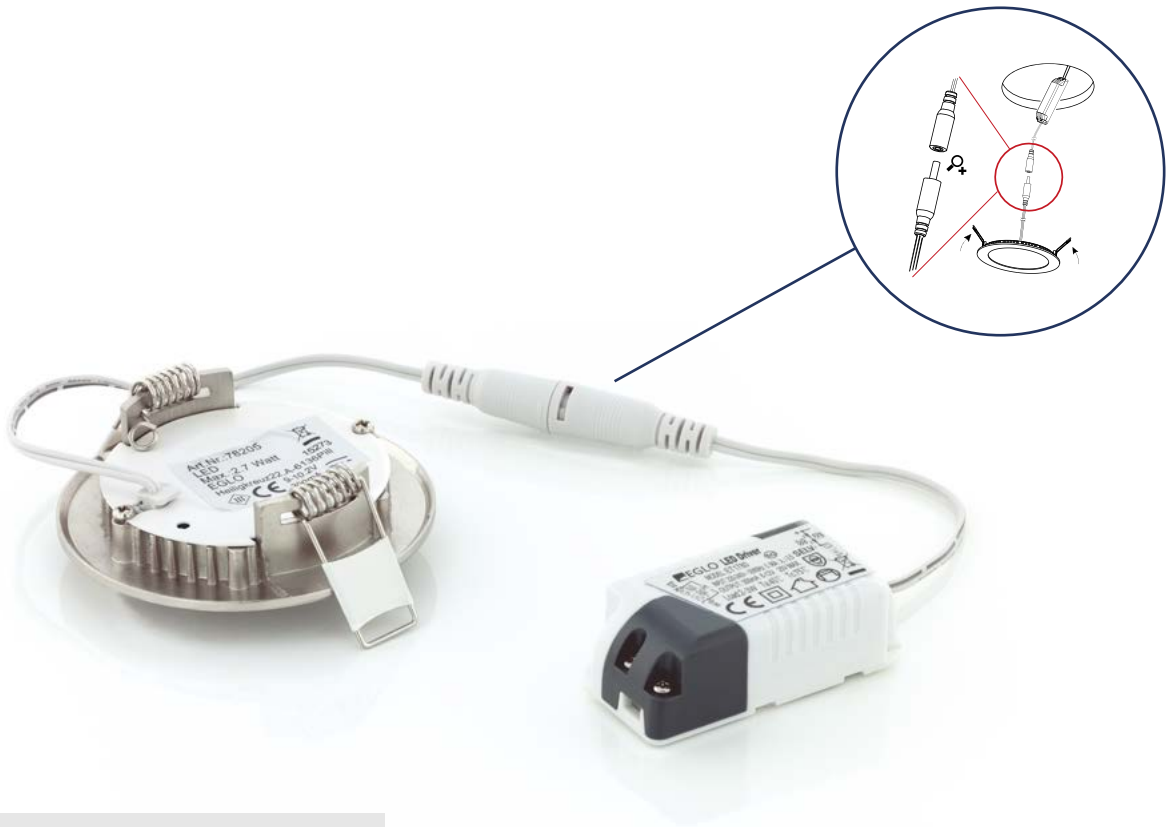

RECESSED LUMINAIRES LOW VOLTAGE

LED NIEDERVOLT LED EINBAULEUCHTEN
 ENCASTRABLES LED DE BAS VOLTAGE

Advantages

- › Slim design with minimal installation depth, making it ideal for ceiling structures with little space
- › Uniform distribution of light - ideal for illuminating spaces and surfaces
- › Low temperature enhances safety
- › Up to 80% power savings compared to incandescent lamps, easy on your budget and the environment
- › High quality aluminum enclosure
- › Simple cabling through integrated terminal connector on driver

Vorteile

- › Schlanke Bauform mit minimaler Einbautiefe, daher ideal für Deckenkonstruktionen mit wenig Platz
- › Homogene Lichtverteilung – ideal zur Beleuchtung von Räumen und Flächen
- › Geringe Wärmeentwicklung sorgt für mehr Sicherheit
- › Bis zu 80% Stromersparnis gegenüber Glühlampen, schont Ihr Budget und die Umwelt
- › Hochwertiges Aluminiumgehäuse
- › Einfache Verkabelung durch integrierten Klemmanschluß am Treiber

Avantages

- › Conception mince avec la profondeur d'installation minimale, idéal pour les structures de plafond avec peu d'espace
- › Distribution uniforme de la lumière - idéal pour l'illumination des espaces et surfaces
- › Faible chaleur améliore la sécurité
- › Jusqu'à 80% d'économies d'énergie par rapport aux lampes à incandescence, réduit votre budget et protège l'environnement
- › Boîtier en aluminium de haute qualité
- › Câblage simple via le connecteur de terminal intégré sur conducteur



standard

dimmable / dimmbar / graduable

adjustable / schwenkbar / orientable

Bathroom / Badezimmer / Salle de bain IP44

crystal effect / Kristalleffekt / crystal effect

furniture installation lights / Möbeleinbauleuchten / luminaires de meubles



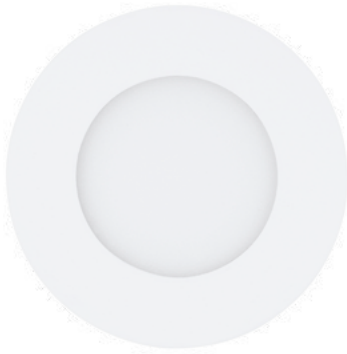

94041

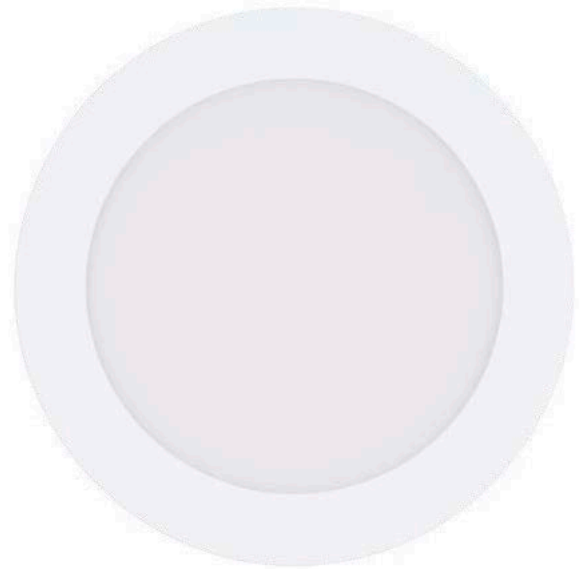

94055

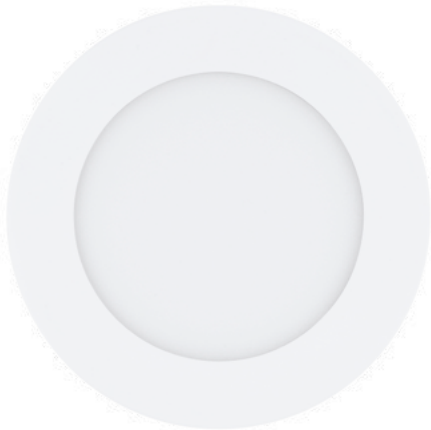

94047



94041 FUEVA 1

recessed luminaire; cast metal, white / plastic, white
Einbauleuchte; Metallguss, weiss / Kunststoff, weiss
luminaire encastrable; fonte métallique, blanc / plastique, blanc

Ø 85, ET 30



2,7W 300lm

Ø 73



9 002759 940416



Ø 85

94047 FUEVA 1

recessed luminaire; cast metal, white / plastic, white
Einbauleuchte; Metallguss, weiss / Kunststoff, weiss
luminaire encastrable; fonte métallique, blanc / plastique, blanc

Ø 120, ET 30



5,5W 600lm

Ø 108



9 002759 940478



Ø 120

94055 FUEVA 1

recessed luminaire; cast metal, white / plastic, white
Einbauleuchte; Metallguss, weiss / Kunststoff, weiss
luminaire encastrable; fonte métallique, blanc / plastique, blanc

Ø 170, ET 30



10,9W 1200lm

Ø 155



9 002759 940553



Ø 170

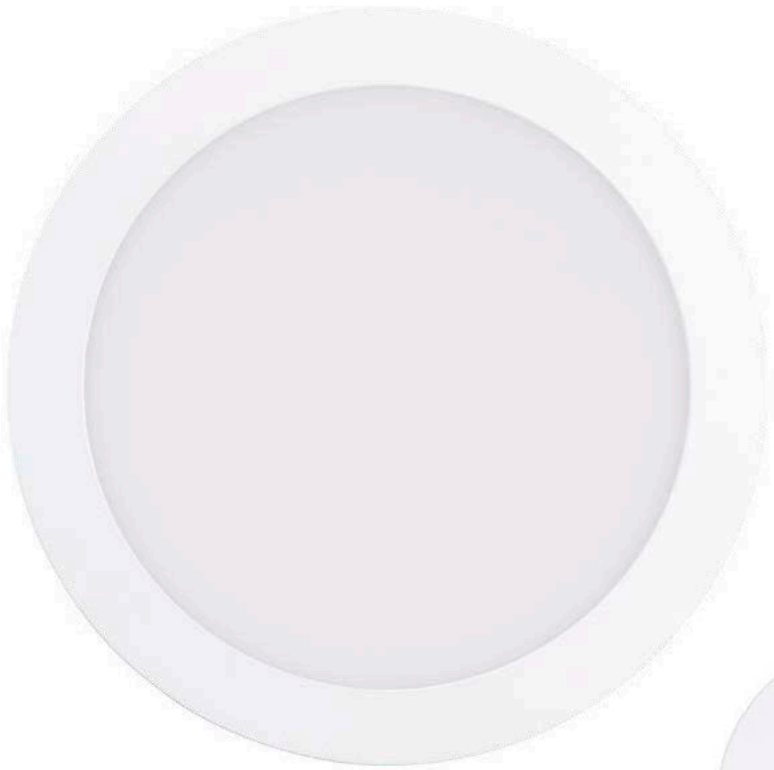

94063

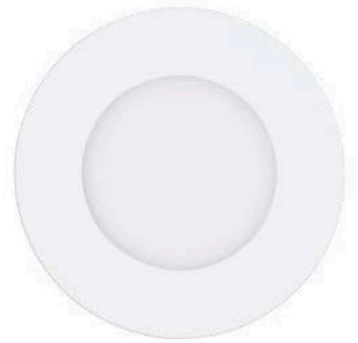
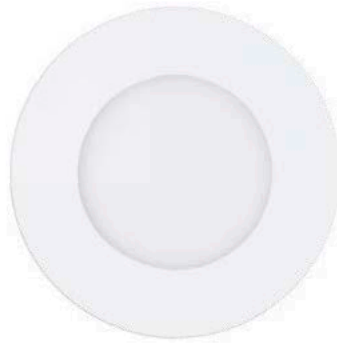

94732



94063 FUEVA 1

recessed luminaire; cast metal, white / plastic, white
Einbauleuchte; Metallguss, weiss / Kunststoff, weiss
luminaire encastrable; fonte métallique, blanc / plastique, blanc

Ø 225, ET 30



16,5W 1600lm

Ø207

94732 FUEVA 1

recessed luminaire; cast metal, white / plastic, white
Einbauleuchte; Metallguss, weiss / Kunststoff, weiss
luminaire encastrable; fonte métallique, blanc / plastique, blanc

Ø 85, ET 30



3x 2,7W 900lm

Ø73



9 002759 940638

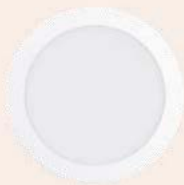

Ø 225



9 002759 947323



Ø 85





94518



31671



94521



94518 FUEVA 1

recessed luminaire; cast metal, satin nickel / plastic, white
Einbauleuchte; Metallguss, nickel-matt / Kunststoff, weiss
luminaire encastrable; fonte métallique, nickel mat / plastique, blanc

Ø 85, ET 30



2,7W 300lm

Ø 73

94521 FUEVA 1

recessed luminaire; cast metal, satin nickel / plastic, white
Einbauleuchte; Metallguss, nickel-matt / Kunststoff, weiss
luminaire encastrable; fonte métallique, nickel mat / plastique, blanc

Ø 120, ET 30



5,5W 600lm

Ø 108

31671 FUEVA 1

recessed luminaire; cast metal, satin nickel / plastic, white
Einbauleuchte; Metallguss, nickel-matt / Kunststoff, weiss
luminaire encastrable; fonte métallique, nickel mat / plastique, blanc

Ø 170, ET 30



10,9W 1200lm

Ø 155



9 002759 945183



Ø 85



9 002759 945213



Ø 120



9 002759 316716



Ø 170



31675



94734



31675 FUEVA 1

recessed luminaire; cast metal, satin nickel / plastic, white
Einbauleuchte; Metallguss, nickel-matt / Kunststoff, weiss
luminaire encastrable; fonte métallique, nickel mat / plastique, blanc

Ø 225, ET 30



16,5W 1600lm

Ø207

94734 FUEVA 1

recessed luminaire; cast metal, satin nickel / plastic, white
Einbauleuchte; Metallguss, nickel-matt / Kunststoff, weiss
luminaire encastrable; fonte métallique, nickel mat / plastique, blanc

Ø 85, ET 30



3x 2,7W 900lm

Ø73



9 002759 316754

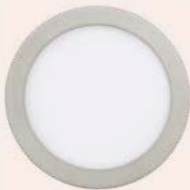

Ø 225



9 002759 947347



Ø 85



RECESSED



RECESSED

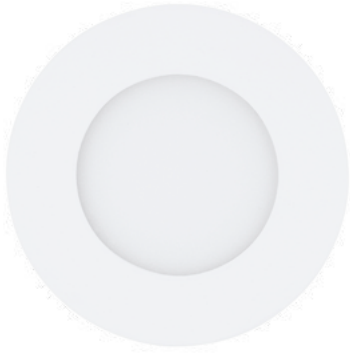

94043

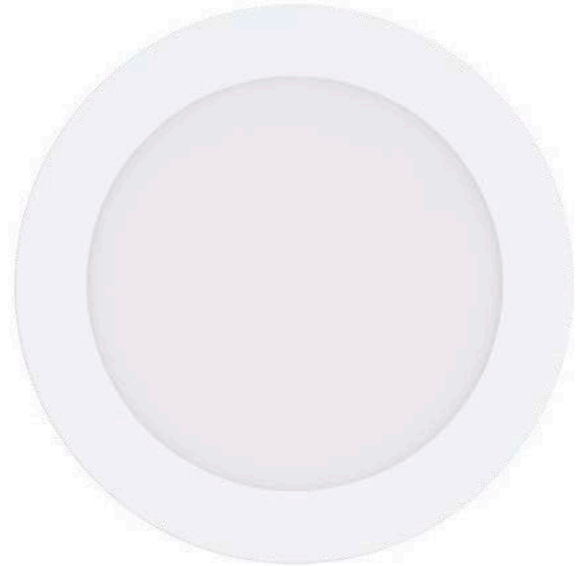

94058

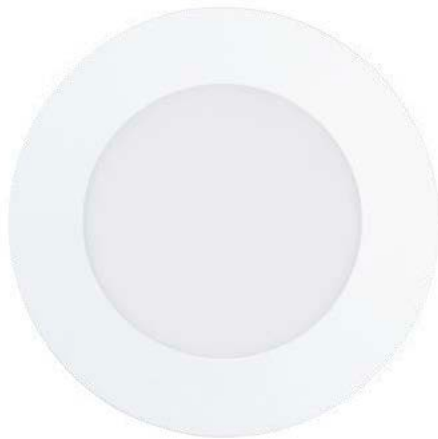

94051



94043 FUEVA 1

recessed luminaire; cast metal, white / plastic, white
Einbauleuchte; Metallguss, weiss / Kunststoff, weiss
luminaire encastrable; fonte métallique, blanc / plastique, blanc

Ø 85, ET 30



2,7W 360lm Ø73

94051 FUEVA 1

recessed luminaire; cast metal, white / plastic, white
Einbauleuchte; Metallguss, weiss / Kunststoff, weiss
luminaire encastrable; fonte métallique, blanc / plastique, blanc

Ø 120, ET 30



5,5W 700lm Ø108

94058 FUEVA 1

recessed luminaire; cast metal, white / plastic, white
Einbauleuchte; Metallguss, weiss / Kunststoff, weiss
luminaire encastrable; fonte métallique, blanc / plastique, blanc

Ø 170, ET 30



10,9W 1350lm Ø155



9 002759 940430



Ø 85



9 002759 940515



Ø 120



9 002759 940584



Ø 170

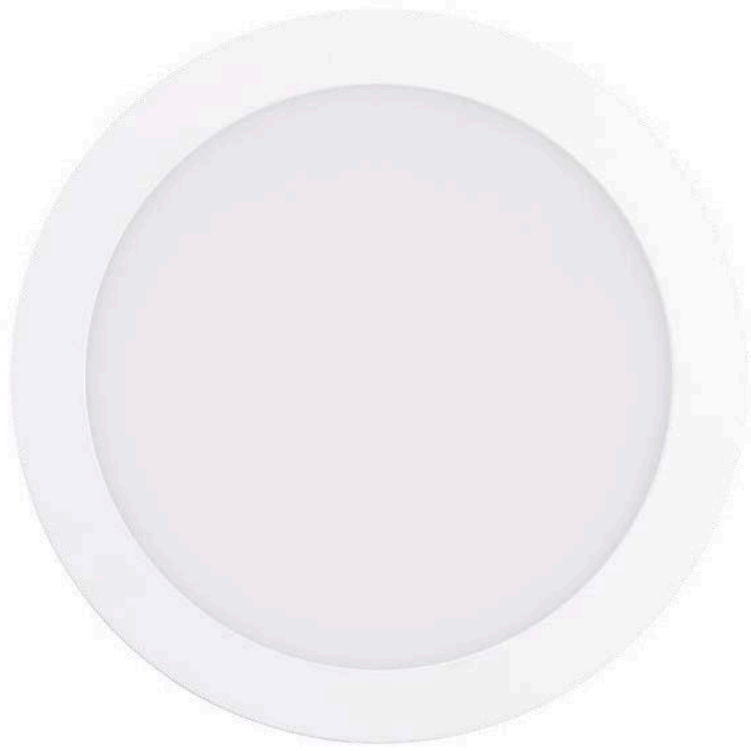

94066



94051

94066 FUEVA 1

recessed luminaire; cast metal, white / plastic, white
Einbauleuchte; Metallguss, weiss / Kunststoff, weiss
luminaire encastrable; fonte métallique, blanc / plastique, blanc

Ø 225, ET 30



18W

2080lm

Ø207

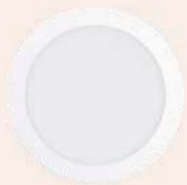

Ø 225





95465



31672



95467



95465 FUEVA 1

recessed luminaire; cast metal, satin nickel / plastic, white
Einbauleuchte; Metallguss, nickel-matt / Kunststoff, weiss
luminaire encastrable; fonte métallique, nickel mat / plastique, blanc

Ø 85, ET 30



2,7W 360lm

Ø 73

95467 FUEVA 1

recessed luminaire; cast metal, satin nickel / plastic, white
Einbauleuchte; Metallguss, nickel-matt / Kunststoff, weiss
luminaire encastrable; fonte métallique, nickel mat / plastique, blanc

Ø 120, ET 30



5,5W 700lm

Ø 108

31672 FUEVA 1

recessed luminaire; cast metal, satin nickel / plastic, white
Einbauleuchte; Metallguss, nickel-matt / Kunststoff, weiss
luminaire encastrable; fonte métallique, nickel mat / plastique, blanc

Ø 170, ET 30



10,9W 1350lm

Ø 155



9 002759 954659



Ø 85



9 002759 954673



Ø 120



9 002759 316723



Ø 170



31676



RECESSED LUMINAIRES LOW VOLTAGE LED
STANDARD



31676

31676 FUEVA 1

recessed luminaire; cast metal, satin nickel / plastic, white
Einbauleuchte; Metallguss, nickel-matt / Kunststoff, weiss
luminaire encastrable; fonte métallique, nickel mat / plastique, blanc

Ø 225, ET 30

18W	2080lm		Ø207	



9 002759 316761

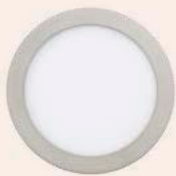

Ø 225

--	--

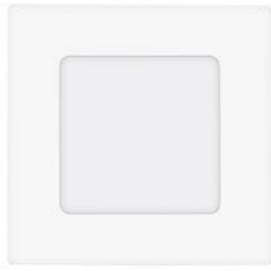

94045

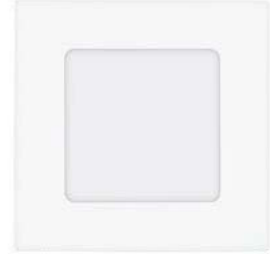
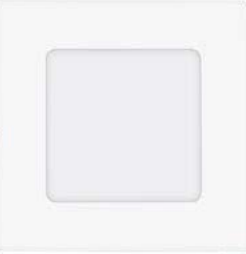
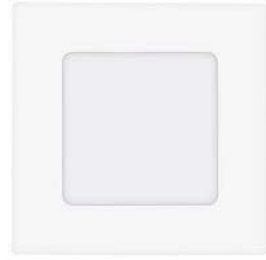

94733

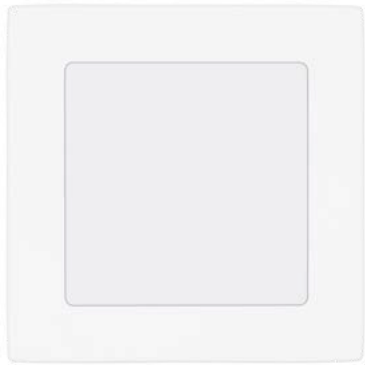

94053

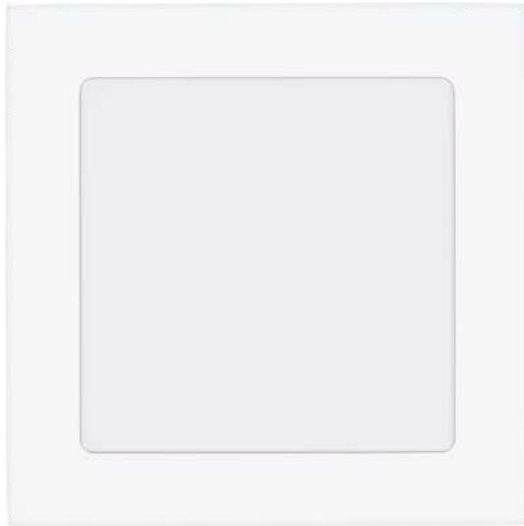

94061



94045 FUEVA 1

recessed luminaire; cast metal, white / plastic, white
Einbauleuchte; Metallguss, weiss / Kunststoff, weiss
luminaire encastrable; fonte métallique, blanc / plastique, blanc

L 85, B 85, ET 30



2,7W 300lm

75x75

94053 FUEVA 1

recessed luminaire; cast metal, white / plastic, white
Einbauleuchte; Metallguss, weiss / Kunststoff, weiss
luminaire encastrable; fonte métallique, blanc / plastique, blanc

L 120, B 120, ET 30



5,5W 600lm

105x105

94061 FUEVA 1

recessed luminaire; cast metal, white / plastic, white
Einbauleuchte; Metallguss, weiss / Kunststoff, weiss
luminaire encastrable; fonte métallique, blanc / plastique, blanc

L 170, B 170, ET 30



10,9W 1200lm

155x155



9 002759 940454

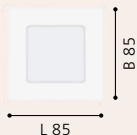

9 002759 940539

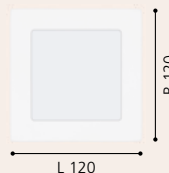

9 002759 940614

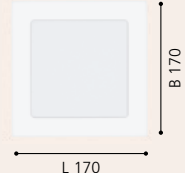

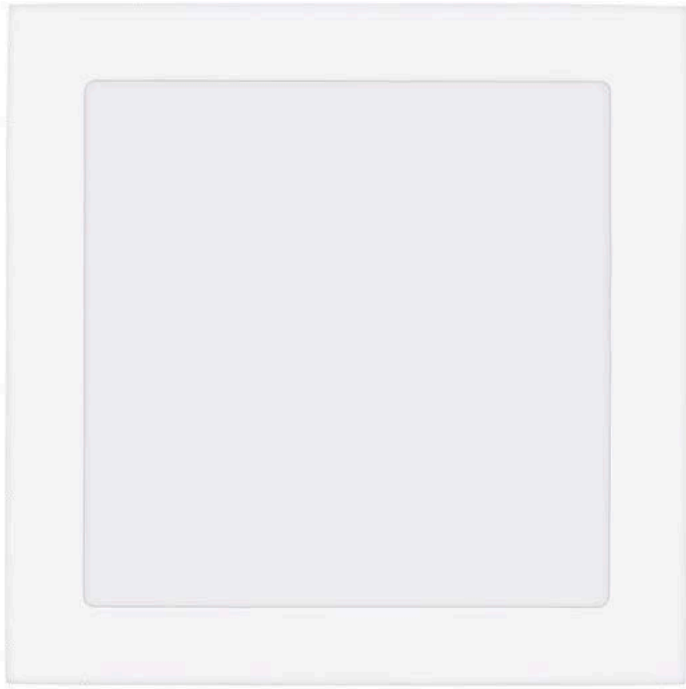

94068



94061

RECESSED LUMINAIRES LOW VOLTAGE LED STANDARD

94068 FUEVA 1

recessed luminaire; cast metal, white / plastic, white
 Einbauleuchte; Metallguss, weiss / Kunststoff, weiss
 luminaire encastrable; fonte métallique, blanc / plastique, blanc

L 225, B 225, ET 30



16,5W 1700lm

205x205

94733 FUEVA 1

recessed luminaire; cast metal, white / plastic, white
 Einbauleuchte; Metallguss, weiss / Kunststoff, weiss
 luminaire encastrable; fonte métallique, blanc / plastique, blanc

L 85, B 85, ET 30



3x 2,7W 900lm

75x75



9 002759 940683

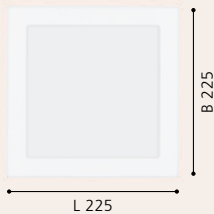

9 002759 947330

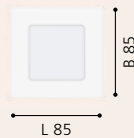



94519



94735



94522



31673



94519 FUEVA 1

recessed luminaire; cast metal, satin nickel / plastic, white
Einbauleuchte; Metallguss, nickel-matt / Kunststoff, weiss
luminaire encastrable; fonte métallique, nickel mat / plastique, blanc

L 85, B 85, ET 30



2,7W 300lm

75x75

94522 FUEVA 1

recessed luminaire; cast metal, satin nickel / plastic, white
Einbauleuchte; Metallguss, nickel-matt / Kunststoff, weiss
luminaire encastrable; fonte métallique, nickel mat / plastique, blanc

L 120, B 120, ET 30



5,5W 600lm

105x105

31673 FUEVA 1

recessed luminaire; cast metal, satin nickel / plastic, white
Einbauleuchte; Metallguss, nickel-matt / Kunststoff, weiss
luminaire encastrable; fonte métallique, nickel mat / plastique, blanc

L 170, B 170, ET 30



10,9W 1200lm

155x155



9 002759 945190



L 85



9 002759 945220



L 120



9 002759 316730

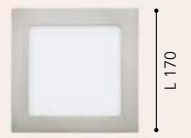

L 170



31677



31677

RECESSED LUMINAIRES LOW VOLTAGE LED
STANDARD

31677 FUEVA 1

recessed luminaire; cast metal, satin nickel / plastic, white
Einbauleuchte; Metallguss, nickel-matt / Kunststoff, weiss
luminaire encastrable; fonte métallique, nickel mat / plastique, blanc

L 225, B 225, ET 30



16,5W 1700lm

205x205

94735 FUEVA 1

recessed luminaire; cast metal, satin nickel / plastic, white
Einbauleuchte; Metallguss, nickel-matt / Kunststoff, weiss
luminaire encastrable; fonte métallique, nickel mat / plastique, blanc

L 85, B 85, ET 30



3x 2,7W 900lm

75x75



9 002759 316778

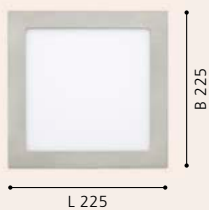

L 225



9 002759 947354

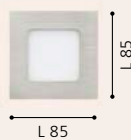

L 85





94046

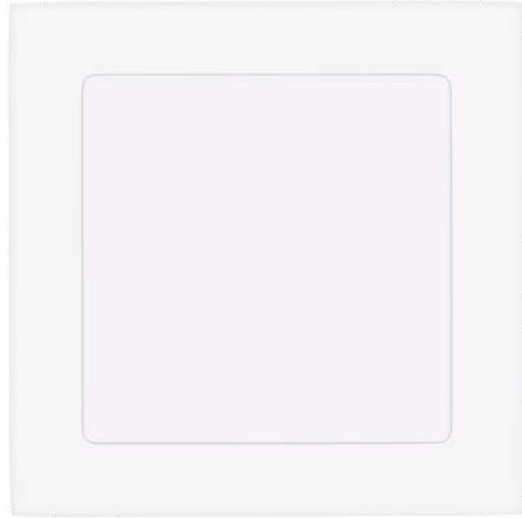

94062



94054



94046 FUEVA 1

recessed luminaire; cast metal, white / plastic, white
Einbauleuchte; Metallguss, weiss / Kunststoff, weiss
luminaire encastrable; fonte métallique, blanc / plastique, blanc

L 85, B 85, ET 30



2,7W 360lm

75x75

94054 FUEVA 1

recessed luminaire; cast metal, white / plastic, white
Einbauleuchte; Metallguss, weiss / Kunststoff, weiss
luminaire encastrable; fonte métallique, blanc / plastique, blanc

L 120, B 120, ET 30



5,5W 700lm

105x105

94062 FUEVA 1

recessed luminaire; cast metal, white / plastic, white
Einbauleuchte; Metallguss, weiss / Kunststoff, weiss
luminaire encastrable; fonte métallique, blanc / plastique, blanc

L 170, B 170, ET 30



10,9W 1350lm

155x155



9 002759 940461

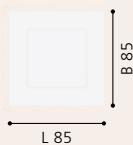

9 002759 940546

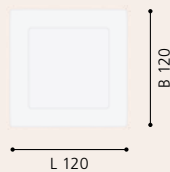

9 002759 940621

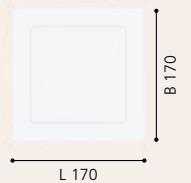

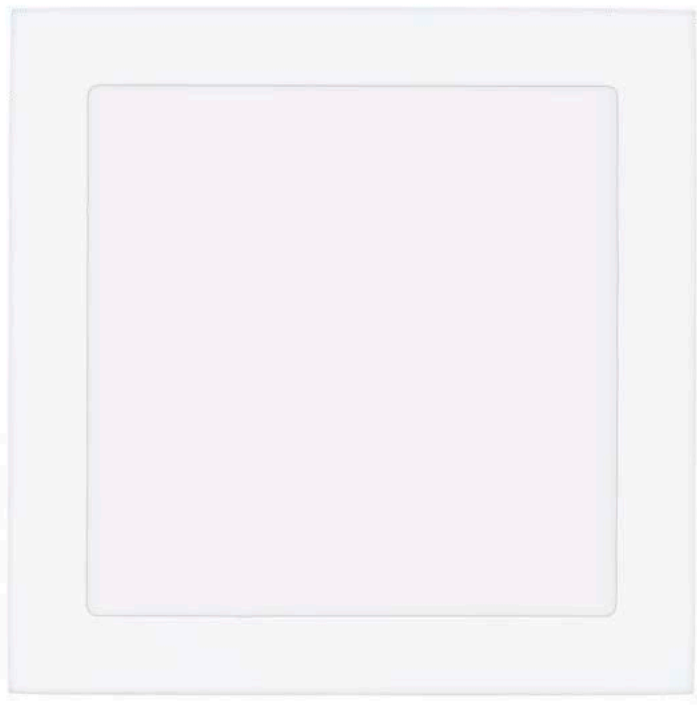

94069



RECESSED LUMINAIRES LOW VOLTAGE LED
STANDARD



94054

94069 FUEVA 1

recessed luminaire; cast metal, white / plastic, white
Einbauleuchte; Metallguss, weiss / Kunststoff, weiss
luminaire encastrable; fonte métallique, blanc / plastique, blanc

L 225, B 225, ET 30



18W 2080lm

205x205

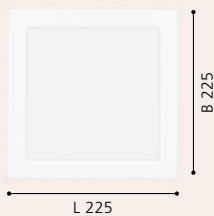



95466



31674



95276



95466 FUEVA 1

recessed luminaire; cast metal, satin nickel / plastic, white
Einbauleuchte; Metallguss, nickel-matt / Kunststoff, weiss
luminaire encastrable; fonte métallique, nickel mat / plastique, blanc

L 85, B 85, ET 30



2,7W 360lm

75x75

95276 FUEVA 1

recessed luminaire; cast metal, satin nickel / plastic, white
Einbauleuchte; Metallguss, nickel-matt / Kunststoff, weiss
luminaire encastrable; fonte métallique, nickel mat / plastique, blanc

L 120, B 120, ET 30



5,5W 700lm

105x105

31674 FUEVA 1

recessed luminaire; cast metal, satin nickel / plastic, white
Einbauleuchte; Metallguss, nickel-matt / Kunststoff, weiss
luminaire encastrable; fonte métallique, nickel mat / plastique, blanc

L 170, B 170, ET 30



10,9W 1350lm

155x155



9 002759 954666

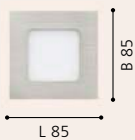

9 002759 952761

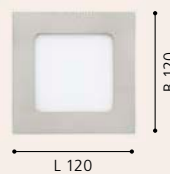

9 002759 316747

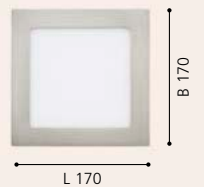



31678



31678 FUEVA 1

recessed luminaire; cast metal, satin nickel / plastic, white
Einbauleuchte; Metallguss, nickel-matt / Kunststoff, weiss
luminaire encastrable; fonte métallique, nickel mat / plastique, blanc

L 225, B 225, ET 30



LED 18W

neutral
WHITE 2080lm

205x205



9 002759 316785

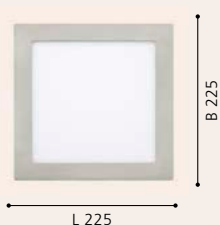

31674



98521



98522



98521 RONZANO 1

recessed luminaire; steel, white, silver
Einbauleuchte; Stahl, weiss, silber
luminaire encastrable; acier, blanc, argent

Ø 165

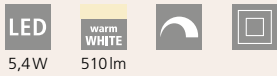

5,4W 510lm



9 002759 985219



Ø 165

98522 RONZANO 1

recessed luminaire; steel, black, silver
Einbauleuchte; Stahl, schwarz, silber
luminaire encastrable; acier, noir, argent

Ø 165

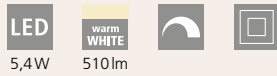

5,4W 510lm



9 002759 985226



Ø 165



98521

RECESSED LUMINAIRES LOW VOLTAGE LED
ADJUSTABLE / SCHWENKBAR / ORIENTABLE



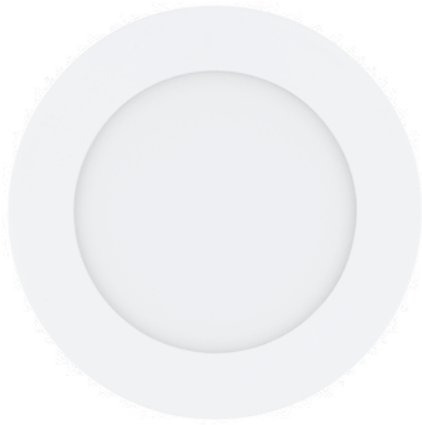

94048

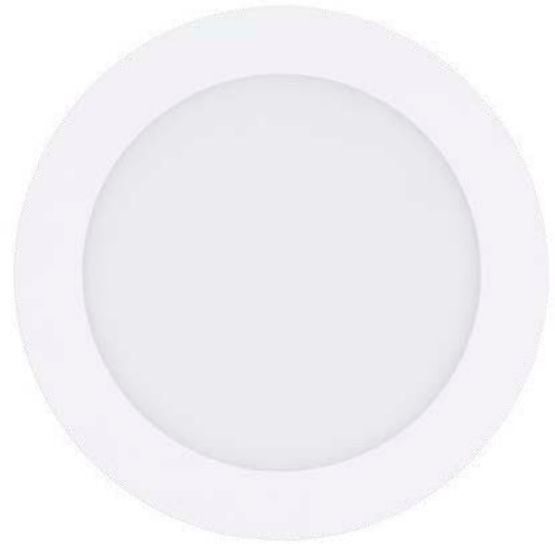

94056



96406



96407



94048 FUEVA 1

recessed luminaire; cast metal, white / plastic, white
Einbauleuchte; Metallguss, weiss / Kunststoff, weiss
luminaire encastrable; fonte métallique, blanc / plastique, blanc

Ø 120, ET 30



5,5W 600lm

Ø 108



9 002759 940485



Ø 120

94056 FUEVA 1

recessed luminaire; cast metal, white / plastic, white
Einbauleuchte; Metallguss, weiss / Kunststoff, weiss
luminaire encastrable; fonte métallique, blanc / plastique, blanc

Ø 170, ET 30



10,9W 1200lm

Ø 155



9 002759 940560



Ø 170

94064 FUEVA 1

recessed luminaire; cast metal, white / plastic, white
Einbauleuchte; Metallguss, weiss / Kunststoff, weiss
luminaire encastrable; fonte métallique, blanc / plastique, blanc

Ø 225, ET 30



16,5W 1600lm

Ø 207



9 002759 940645



Ø 225

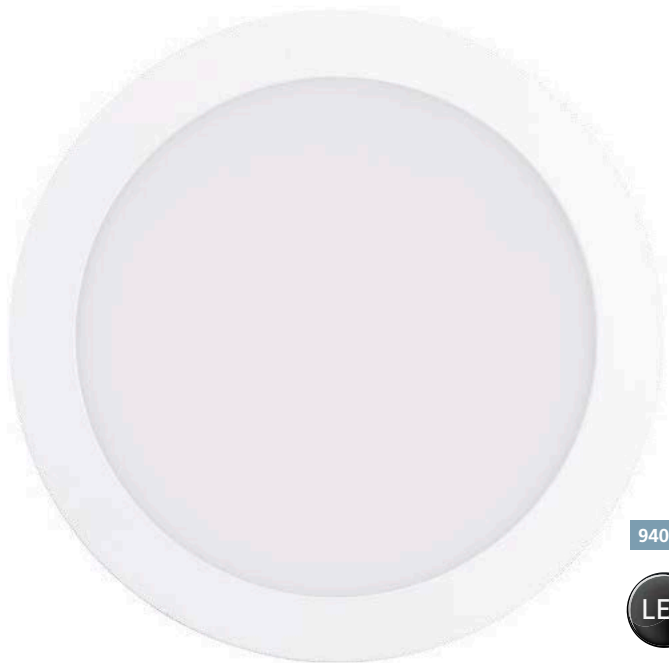

94064

LED



96408

LED



94056

RECESSED LUMINAIRES LOW VOLTAGE LED
DIMMABLE / DIMMBAR / GRADUABLE



96406 FUEVA 1

recessed luminaire; cast metal, satin nickel / plastic, white
Einbauleuchte; Metallguss, nickel-matt / Kunststoff, weiss
luminaire encastrable; fonte métallique, nickel mat / plastique, blanc

Ø 120, ET 30



5,5W 600lm

Ø 108

96407 FUEVA 1

recessed luminaire; cast metal, satin nickel / plastic, white
Einbauleuchte; Metallguss, nickel-matt / Kunststoff, weiss
luminaire encastrable; fonte métallique, nickel mat / plastique, blanc

Ø 170, ET 30



10,95W 1200lm

Ø 155

96408 FUEVA 1

recessed luminaire; cast metal, satin nickel / plastic, white
Einbauleuchte; Metallguss, nickel-matt / Kunststoff, weiss
luminaire encastrable; fonte métallique, nickel mat / plastique, blanc

Ø 225, ET 30



16,47W 1600lm

Ø 207



9 002759 964061



Ø 120



9 002759 964078



Ø 170



9 002759 964085



Ø 225

96165

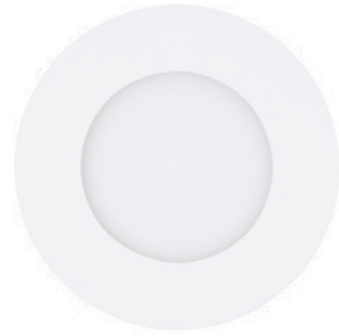

96163

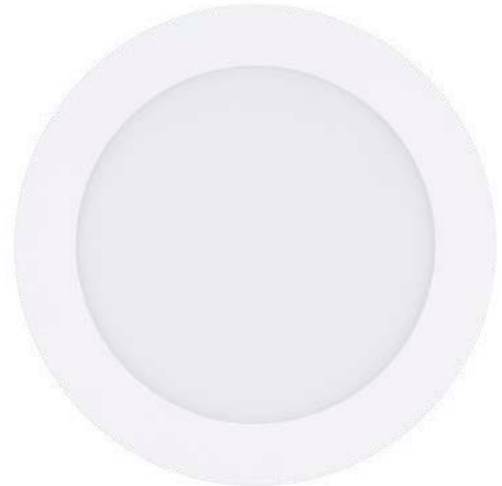

96165



IP44

96163 FUEVA 1

recessed luminaire; cast metal, white / plastic, white
Einbauleuchte; Metallguss, weiss / Kunststoff, weiss
luminaire encastrable; fonte métallique, blanc / plastique, blanc

Ø 85, ET 30

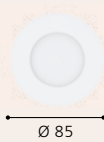

96165 FUEVA 1

recessed luminaire; cast metal, white / plastic, white
Einbauleuchte; Metallguss, weiss / Kunststoff, weiss
luminaire encastrable; fonte métallique, blanc / plastique, blanc

Ø 170, ET 30

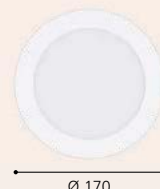

96164 FUEVA 1

recessed luminaire; cast metal, white / plastic, white
Einbauleuchte; Metallguss, weiss / Kunststoff, weiss
luminaire encastrable; fonte métallique, blanc / plastique, blanc

Ø 85, ET 30



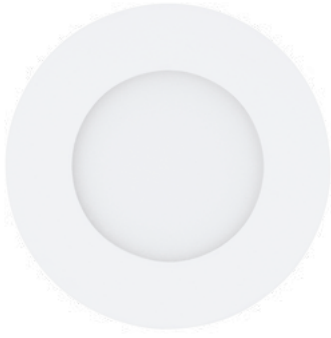

96164

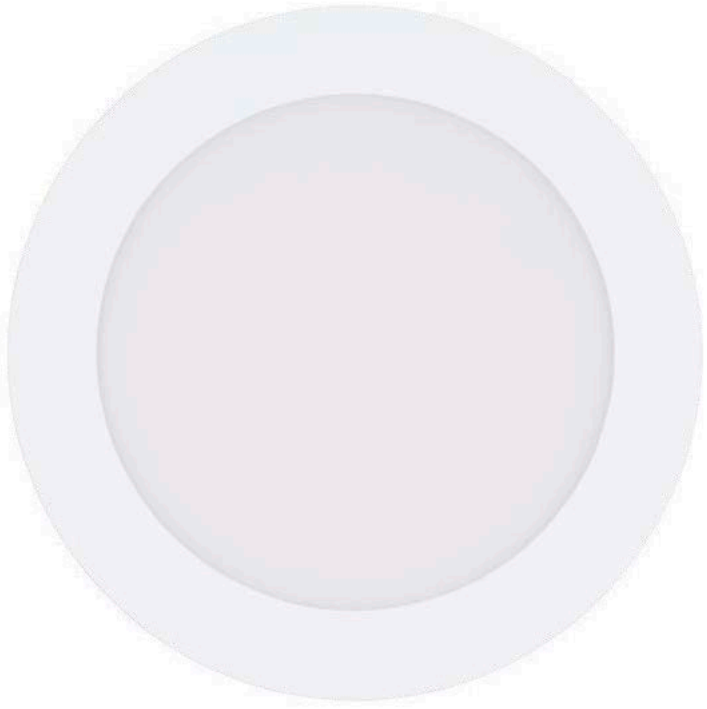

96166



96166 FUEVA 1

recessed luminaire; cast metal, white / plastic, white
Einbauleuchte; Metallguss, weiss / Kunststoff, weiss
luminaire encastrable; fonte métallique, blanc / plastique, blanc

Ø 170, ET 30

- LED
10,9W
- neutral
WHITE
1350lm
-
-
- IP44



FUEVA 1

These luminaires are protected against splash water.

Diese Leuchten sind gegen Spritzwasser geschützt.

Les luminaires sont protégées contre les éclaboussures d'eau.

	0	1	2	3
IP44				
EU	X	X	✓	✓
FR	X	X	X	✓



96055



96053



96054



96053 FUEVA 1

recessed luminaire; cast metal, chrome / plastic, white
Einbauleuchte; Metallguss, chrom / Kunststoff, weiss
luminaire encastrable; fonte métallique, chrome / plastique, blanc

Ø 85, ET 30



Ø 85



96055



96056



96055 FUEVA 1

recessed luminaire; cast metal, chrome / plastic, white
Einbauleuchte; Metallguss, chrom / Kunststoff, weiss
luminaire encastrable; fonte métallique, chrome / plastique, blanc

Ø 170, ET 30



10,9W 1200lm

Ø 155 IP44



9 002759 960551



Ø 170

96054 FUEVA 1

recessed luminaire; cast metal, chrome / plastic, white
Einbauleuchte; Metallguss, chrom / Kunststoff, weiss
luminaire encastrable; fonte métallique, chrome / plastique, blanc

Ø 85, ET 30



2,7W 360lm

Ø 74 IP44



9 002759 960544



Ø 85

96056 FUEVA 1

recessed luminaire; cast metal, chrome / plastic, white
Einbauleuchte; Metallguss, chrom / Kunststoff, weiss
luminaire encastrable; fonte métallique, chrome / plastique, blanc

Ø 170, ET 30



10,9W 1350lm

Ø 155 IP44



9 002759 960568



Ø 170



97591



97592



97593



97591 FIOBBO

recessed luminaire; steel, white / plastic with crystal effect, white

Einbauleuchte; Stahl, weiss / Kunststoff m.Kristalleffekt, weiss
luminaire encastrable; acier, blanc / plastique avec effet cristal, blanc

H 43, Ø 120, ET 35



5W 640lm Ø 105

97592 FIOBBO

recessed luminaire; steel, white / plastic with crystal effect, white

Einbauleuchte; Stahl, weiss / Kunststoff m.Kristalleffekt, weiss
luminaire encastrable; acier, blanc / plastique avec effet cristal, blanc

H 43, Ø 170, ET 35



10W 1100lm Ø 155

97593 FIOBBO

recessed luminaire; steel, white / plastic with crystal effect, white

Einbauleuchte; Stahl, weiss / Kunststoff m.Kristalleffekt, weiss
luminaire encastrable; acier, blanc / plastique avec effet cristal, blanc

H 50, Ø 225, ET 40



14W 1700lm Ø 205



9 002759 975913



9 002759 975920



9 002759 975937





97594



LED

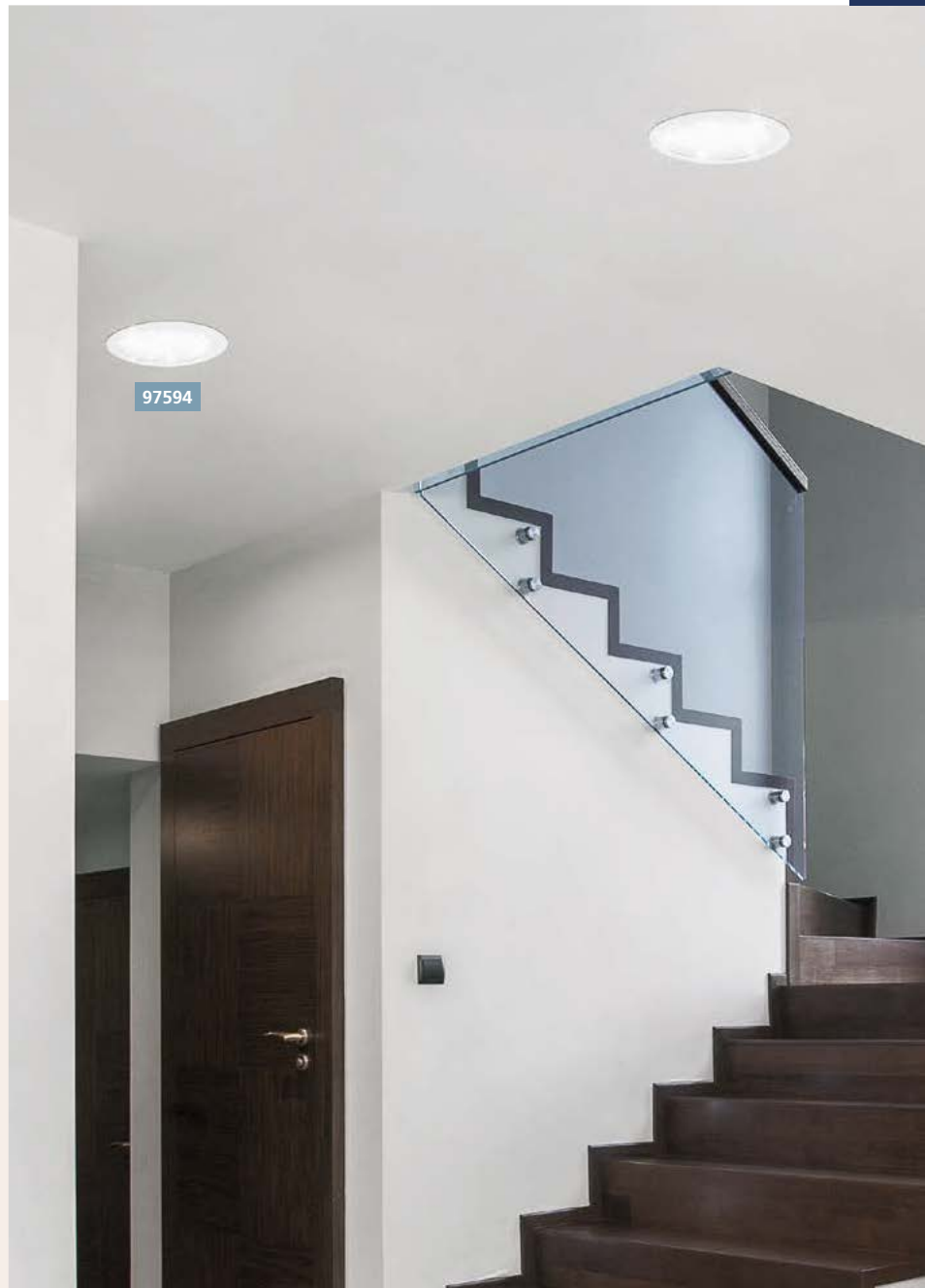

97594

97594 FIOBBO

recessed luminaire; steel, white / plastic with crystal effect, white

Einbauleuchte; Stahl, weiss / Kunststoff m. Kristalleffekt, weiss
luminaire encastrable; acier, blanc / plastique avec effet cristal, blanc

H 50, Ø 300, ET 40



21 W 2500 lm

Ø 280



9 002759 975944



Ø 300





97079



CHANGO

- | | | |
|---------------------------------|-----------------------------------|------------------------------------|
| > "Starry Sky" 3 Spot Set | > "Sternenhimmel" 3 Spot Set | > Ensemble 3 spots "Ciel étoilé" |
| > Simple installation | > Einfache Montage | > Installation simple |
| > Pre-assembled connecting box | > Vorkonfigurierte Anschlußbox | > Boîte de connexion pré-assemblée |
| > Plug & Play | > Plug & Play | > Branchez & jouez |
| > Desktop driver | > Desktop Treiber | > Pilote de bureau |
| > Operable with 2 – 3 spotheads | > Verwendbar mit 2 – 3 Spotköpfen | > Utilisable avec 2 à 3 têtes |
| incl. short-connector | inkl. Verbinder | incl. connecteur court |
| > Cable length = 2m | > Kabellänge = 2m | > Longueur du câble = 2m |
| > Cutout dimension = 16 mm | > Ausschnitt Durchmesser = 16 mm | > Cote de découpe = 16 mm |

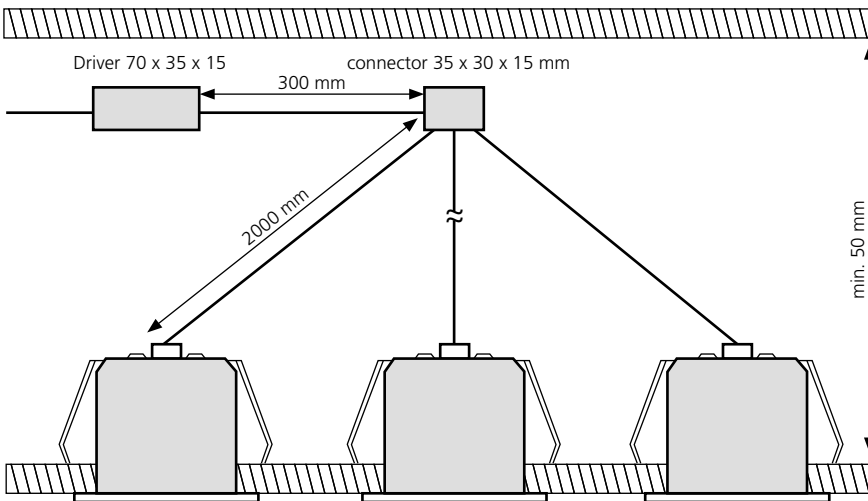

97079 CHANGO

recessed luminaire; aluminium, white
Einbauleuchte; Alu, weiss
luminaire encastrable; aluminium, blanc

H 22, Ø 32, ET 25

LED warm WHITE 3x 1W 3x 100lm Ø15 IP44



A++ RECESSED





97079

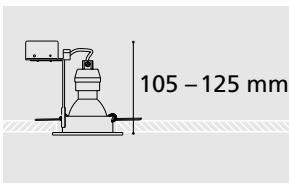

RECESSED LUMINAIRES GU10 LED

EINBAULEUCHTEN GU10 LED

LUMINAIRES ENCASTRÉS GU10 LED

Advantages

- › Proven technology, customized solutions in every price category
- › Depending on the selected lamps appropriate for illuminating areas and rooms or for accent lighting
- › Great colors and shapes
- › Up to 80 % power savings compared to incandescent lamps, easy on your budget and the environment
- › Lamp replaceable from the bottom
- › Fits for all GU-10 LED types

Vorteile

- › Bewährte Technologie, individuelle Lösungen in jeder Preisklasse
- › Je nach eingesetztem Leuchtmittel zur Beleuchtung von Flächen und Räumen oder zur Akzentbeleuchtung
- › Große Farben- und Formenvielfalt
- › Bis zu 80 % Stromersparnis gegenüber Glühlampen, schont Ihr Budget und die Umwelt
- › Leuchtmittel von unten tauschbar
- › Passend für jedes GU-10 LED Leuchtmittel

Avantages

- › Une technologie éprouvée, solutions individuelles dans chaque catégorie de prix
- › Selon les lampes choisies apte à éclairer des surfaces et des chambres ou pour l'éclairage accentuel
- › Couleurs et formes fantastiques
- › Jusqu'à 80 % d'économies d'énergie par rapport aux lampes à incandescence, réduit votre budget et protège l'environnement
- › Lampe remplaçable par le bas
- › Convient pour tous les types de GU10 LED

rigid / starr / fixe

adjustable / schwenkbar / orientable

Cast aluminium adjustable / Aluguß schwenkbar / fonte d'aluminium orientable

Step-Dimming

excl. bulb adjustable / exkl. Leuchtmittel schwenkbar / orientable ampoule exclus

isolated ceilings / isolierte Decken / plafond isolé



94235



94237



94236



94235 PENETO

recessed luminaire; steel, white
Einbauleuchte; Stahl, weiss
luminaire encastrable; acier, blanc

94237 PENETO

recessed luminaire; steel, satin nickel
Einbauleuchte; Stahl, nickel-matt
luminaire encastrable; acier, nickel mat

94236 PENETO

recessed luminaire; steel, chrome
Einbauleuchte; Stahl, chrom
luminaire encastrable; acier, chrome

Ø 78, ET 115



Ø 78, ET 115



Ø 78, ET 115



9 002759 942359



Ø 78



9 002759 942373



Ø 78



9 002759 942366



Ø 78



94237

RECESSED LUMINAIRES GU10 LED
RIGID / STARR / FIXE



94239



94242



94406



94239 PENETO

recessed luminaire; steel, white
Einbauleuchte; Stahl, weiss
luminaire encastrable; acier, blanc

94406 PENETO

recessed luminaire; steel, white
Einbauleuchte; Stahl, weiss
luminaire encastrable; acier, blanc

94242 PENETO

recessed luminaire; steel, satin nickel
Einbauleuchte; Stahl, nickel-matt
luminaire encastrable; acier, nickel mat

Ø 87, ET 115



Ø 87, ET 115



Ø 87, ET 115



9 002759 942397

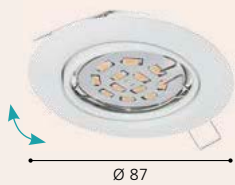

9 002759 944063

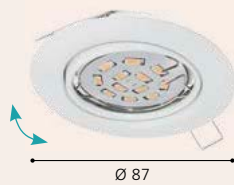

9 002759 942427

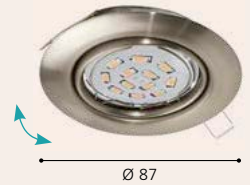



94408

LED



94407

LED



94241

LED

RECESSED LUMINAIRES GU10 LED
ADJUSTABLE / SCHWENKBAR / ORIENTABLE



94408 PENETO

recessed luminaire; steel, satin nickel
Einbauleuchte; Stahl, nickel-matt
luminaire encastrable; acier, nickel mat

94241 PENETO

recessed luminaire; steel, chrome
Einbauleuchte; Stahl, chrom
luminaire encastrable; acier, chrome

94407 PENETO

recessed luminaire; steel, chrome
Einbauleuchte; Stahl, chrom
luminaire encastrable; acier, chrome

Ø 87, ET 115



Ø 87, ET 115



Ø 87, ET 115





94405

RECESSED LUMINAIRES GU10 LED
ADJUSTABLE / SCHWENKBAR / ORIENTABLE



94243

LED



94405

LED

94243 PENETO

recessed luminaire; steel, bronzed
Einbauleuchte; Stahl, brüniert
luminaire encastrable; acier, bruni

94405 PENETO

recessed luminaire; steel, brass
Einbauleuchte; Stahl, messing
luminaire encastrable; acier, laiton

Ø 87, ET 115



Ø 87, ET 115





94262



94264



94262 PENETO

recessed luminaire; steel, white
Einbauleuchte; Stahl, weiss
luminaire encastrable; acier, blanc

94264 PENETO

recessed luminaire; steel, satin nickel
Einbauleuchte; Stahl, nickel-matt
luminaire encastrable; acier, nickel mat

L 87, B 87, ET 115



L 87, B 87, ET 115

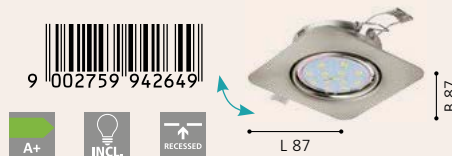



31682



31688



31683



31682 TEDO

recessed luminaire; cast aluminium, white
 Einbauleuchte; Aluguss, weiss
 luminaire encastrable; fonte d'aluminium, blanc

Ø 80, ET 115



9 002759 316822



Ø 80

31683 TEDO

recessed luminaire; cast aluminium, white
 Einbauleuchte; Aluguss, weiss
 luminaire encastrable; fonte d'aluminium, blanc

Ø 80, ET 115



9 002759 316839



Ø 80

31688 TEDO

recessed luminaire; cast aluminium, satin nickel
 Einbauleuchte; Aluguss, nickel-matt
 luminaire encastrable; fonte d'aluminium, nickel mat

Ø 80, ET 115



9 002759 316884



Ø 80



31689

LED

RECESSED LUMINAIRES GU10 LED
CAST ALUMINIUM, ADJUSTABLE / ALUGUSS, SCHWENKBAR / FONTE D'ALUMINIUM, ORIENTABLE



31689 TEDO

recessed luminaire; cast aluminium, satin nickel
Einbauleuchte; Aluguss, nickel-matt
luminaire encastrable; fonte d'aluminium, nickel mat

Ø 80, ET 115



GU10

3x 5W

warm
WHITE
3x
400lm

Ø68



9 002759 316891



Ø 80

A+

INCL.

RECESSED



Dimming without a dimmer?

There's no need for a dimmer anymore, and no need to spend money on an expensive modern LED-capable one.

The luminaire automatically switches to the next dimming level when it is switched off and on again within 3 seconds. If the luminaire stays off for more than 3 seconds, the next activation will automatically return to full lighting. You don't need to switch through all levels the next day.

Note

Our step dimming illuminants are only dimmable via the on/off switch. Operation with a conventional dimmer is not intended and may cause permanent damage to the electronics. The illuminants are therefore marked as "not dimmable" according to European regulations.

Dimmen ohne Dimmer?

Kein Dimmer mehr notwendig – Sie ersparen sich somit hohe Anschaffungskosten für einen modernen LED-fähigen Dimmer.

Wird die Leuchte innerhalb von 3 Sekunden aus- und wieder eingeschaltet, wechselt es automatisch in die nächste Dimmstufe. Bleibt die Leuchte länger als 3 Sekunden ausgeschaltet, stehen Ihnen beim nächsten Einschalten automatisch wieder 100 % Leuchtkraft zur Verfügung – Sie ersparen sich also das mühsame Durchschalten am nächsten Tag.

Hinweis

Unsere Stepdimming-Leuchtmittel sind nur über Ein-/Ausschalter dimmbar – der Betrieb mit konventionellen Dimmern ist nicht vorgesehen und könnte die Elektronik dauerhaft beschädigen. Die Leuchtmittel werden daher gemäß europäischer Vorschriften als „nicht dimmbar“ gekennzeichnet.

Graduer sans graduateur ?

Aucun graduateur n'est nécessaire – Vous vous épargnez ainsi les coûts d'acquisition élevés pour un graduateur DEL moderne.

Lorsque le luminaire est éteint, puis rallumé en l'espace de 3 secondes, il passe automatiquement au prochain niveau de graduation. Lorsque le luminaire reste éteint plus de 3 secondes, vous aurez à nouveau automatiquement 100 % de la force lumineuse lors du prochain allumage – Vous vous épargnez alors la commutation fatigante le lendemain.

Remarque

Nos ampoules à graduation par niveau sont graduable uniquement par l'interrupteur marche / arrêt – le service avec un graduateur conventionnel n'est pas prévu et pourrait endommager l'électronique à long terme. Les ampoules sont alors marquées par « non graduable », selon les réglementations européenne.



95357



95359



95357 TEDO 1

recessed luminaire; cast aluminium, white
Einbauleuchte; Aluguss, weiss
luminaire encastrable; fonte d'aluminium, blanc

Ø 80, ET 115





96616

EXCL.
BULB



96617

EXCL.
BULB

95359 TEDO 1

recessed luminaire; cast aluminium, satin nickel
Einbauleuchte; Aluguss, nickel-matt
luminaire encastrable; fonte d'aluminium, nickel mat

Ø 80, ET 115



96616 TEDO

recessed luminaire; cast aluminium, white
Einbauleuchte; Aluguss, weiss
luminaire encastrable; fonte d'aluminium, blanc

Ø 80, ET 115



96617 TEDO

recessed luminaire; cast aluminium, satin nickel
Einbauleuchte; Aluguss, nickel-matt
luminaire encastrable; fonte d'aluminium, nickel mat

Ø 80, ET 115



9 002759 953591



Ø 80



9 002759 966164



Ø 80



9 002759 966171



Ø 80

5

year warranty
Jahre Garantie
ans de garantie
anni di garanzia
años de garantía
anos de garantía

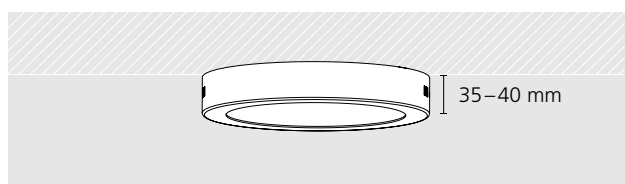

SURFACE MOUNTED LED LUMINAIRES

LED AUFBAULEUCHTEN
LUMINAIRES EN SAILLIE

Advantages

- › Slim design with low surface height (35 to 40 mm)
- › Uniform distribution of indirect light - ideal for illuminating spaces and surfaces
- › Low temperature enhances safety
- › Up to 80% power savings compared to incandescent lamps, easy on your budget and the environment
- › High quality aluminium enclosure

Vorteile

- › Schlanke Bauform mit geringer Aufbauhöhe (35 bis 40 mm)
- › Homogenes, indirektes Licht – ideal zur Beleuchtung von Räumen und Flächen
- › Geringe Wärmeentwicklung sorgt für mehr Sicherheit
- › Bis zu 80 % Stromersparnis gegenüber Glühlampen, schont Ihr Budget und die Umwelt
- › Hochwertiges Aluminiumgehäuse

Avantages

- › Conception mince avec la hauteur de saillie minimale (de 35 à 40 mm)
- › La distribution uniforme de la lumière indirecte - idéal pour les espaces et les surfaces éclairantes
- › Faible chaleur améliore la sécurité
- › Jusqu'à 80% d'économies d'énergie par rapport aux lampes à incandescence, réduit votre budget et protège l'environnement
- › boîtier en aluminium de haute qualité

Standard

bathroom / Badezimmer / Salle de bain

decorative / dekorativ / décoratif





94071



94535



94075



94071 FUEVA 1

surface-mounted luminaire; cast metal, white / plastic, white
Aufbauleuchte; Metallguss, weiss / Kunststoff, weiss
luminaire en saillie; fonte métallique, blanc / plastique, blanc

H 40, Ø 170



10,9W 1200lm



9 002759 940713



Ø 170



94075 FUEVA 1

surface-mounted luminaire; cast metal, white / plastic, white
Aufbauleuchte; Metallguss, weiss / Kunststoff, weiss
luminaire en saillie; fonte métallique, blanc / plastique, blanc

H 40, Ø 225



16,5W 1600lm



9 002759 940751



Ø 225



94535 FUEVA 1

surface-mounted luminaire; cast metal, white / plastic, white
Aufbauleuchte; Metallguss, weiss / Kunststoff, weiss
luminaire en saillie; fonte métallique, blanc / plastique, blanc

H 40, Ø 300



22W 2200lm



9 002759 945350



Ø 300





94523



94527



94525



94523 FUEVA 1

surface-mounted luminaire; cast metal, satin nickel / plastic, white
 Aufbauleuchte; Metallguss, nickel-matt / Kunststoff, weiss
 luminaire en saillie; fonte métallique, nickel mat / plastique, blanc

H 40, Ø 170



10,9W 1200lm

94525 FUEVA 1

surface-mounted luminaire; cast metal, satin nickel / plastic, white
 Aufbauleuchte; Metallguss, nickel-matt / Kunststoff, weiss
 luminaire en saillie; fonte métallique, nickel mat / plastique, blanc

H 40, Ø 225



16,5W 1600lm

94527 FUEVA 1

surface-mounted luminaire; cast metal, satin nickel / plastic, white
 Aufbauleuchte; Metallguss, nickel-matt / Kunststoff, weiss
 luminaire en saillie; fonte métallique, nickel mat / plastique, blanc

H 40, Ø 300



22W 2200lm



9 002759 945237



9 002759 945251



9 002759 945275





94072



94536



94076



94072 FUEVA 1

surface-mounted luminaire; cast metal, white / plastic, white
Aufbauleuchte; Metallguss, weiss / Kunststoff, weiss
luminaire en saillie; fonte métallique, blanc / plastique, blanc

H 40, Ø 170



12W 1350lm

94076 FUEVA 1

surface-mounted luminaire; cast metal, white / plastic, white
Aufbauleuchte; Metallguss, weiss / Kunststoff, weiss
luminaire en saillie; fonte métallique, blanc / plastique, blanc

H 40, Ø 225



18W 2080lm

94536 FUEVA 1

surface-mounted luminaire; cast metal, white / plastic, white
Aufbauleuchte; Metallguss, weiss / Kunststoff, weiss
luminaire en saillie; fonte métallique, blanc / plastique, blanc

H 40, Ø 300



24W 2600lm



9 002759 940720



Ø 170



9 002759 940768



Ø 225



9 002759 945367



Ø 300



32441



32443



32442



32441 FUEVA 1

surface-mounted luminaire; cast metal, satin nickel / plastic, white
 Aufbauleuchte; Metallguss, nickel-matt / Kunststoff, weiss
 luminaire en saillie; fonte métallique, nickel mat / plastique, blanc

H 40, Ø 170



12W 1350lm

32442 FUEVA 1

surface-mounted luminaire; cast metal, satin nickel / plastic, white
 Aufbauleuchte; Metallguss, nickel-matt / Kunststoff, weiss
 luminaire en saillie; fonte métallique, nickel mat / plastique, blanc

H 40, Ø 225



18W 2080lm

32443 FUEVA 1

surface-mounted luminaire; cast metal, satin nickel / plastic, white
 Aufbauleuchte; Metallguss, nickel-matt / Kunststoff, weiss
 luminaire en saillie; fonte métallique, nickel mat / plastique, blanc

H 40, Ø 300



24W 2600lm



9 002759 324414



Ø 170



9 002759 324421



Ø 225



9 002759 324438



Ø 300





97262



97279



97271



97262 FUEVA 1

surface-mounted luminaire; aluminium, white / plastic, white
Aufbauleuchte; Alu, weiss / Kunststoff, weiss
luminaire en saillie; aluminium, blanc / plastique, blanc

H 30, Ø 400



25W 2500lm



9 002759 972622

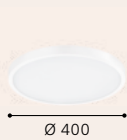

97271 FUEVA 1

surface-mounted luminaire; aluminium, white / plastic, white
Aufbauleuchte; Alu, weiss / Kunststoff, weiss
luminaire en saillie; aluminium, blanc / plastique, blanc

H 30, Ø 500



25W 2700lm



9 002759 972714

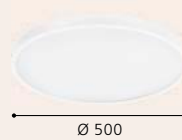

97279 FUEVA 1

surface-mounted luminaire; aluminium, white / plastic, white
Aufbauleuchte; Alu, weiss / Kunststoff, weiss
luminaire en saillie; aluminium, blanc / plastique, blanc

H 30, Ø 600



27W 3200lm



9 002759 972790

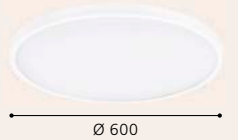



97263



97552



97272



97263 FUEVA 1

surface-mounted luminaire; aluminium, silver / plastic, white
Aufbauleuchte; Alu, silber / Kunststoff, weiss
luminaire en saillie; aluminium, argent / plastique, blanc

H 30, Ø 400



25W 2500lm

97272 FUEVA 1

surface-mounted luminaire; aluminium, silver / plastic, white
Aufbauleuchte; Alu, silber / Kunststoff, weiss
luminaire en saillie; aluminium, argent / plastique, blanc

H 30, Ø 500



25W 2700lm

97552 FUEVA 1

surface-mounted luminaire; aluminium, silver / plastic, white
Aufbauleuchte; Alu, silber / Kunststoff, weiss
luminaire en saillie; aluminium, argent / plastique, blanc

H 30, Ø 600



27W 3200lm



9 002759 972639



9 002759 972721



9 002759 975524

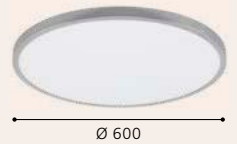



97275



97266

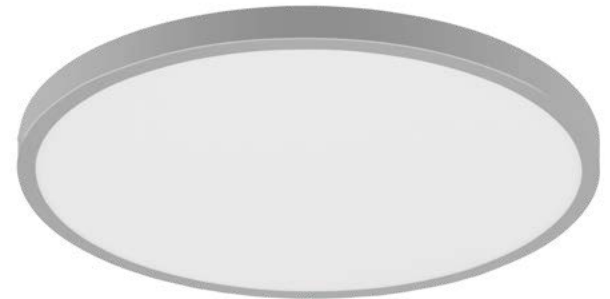

97267



97266 FUEVA 1

surface-mounted luminaire; aluminium, white / plastic, white
Aufbauleuchte; Alu, weiss / Kunststoff, weiss
luminaire en saillie; aluminium, blanc / plastique, blanc

H 30, Ø 400



25W 2500lm

97275 FUEVA 1

surface-mounted luminaire; aluminium, white / plastic, white
Aufbauleuchte; Alu, weiss / Kunststoff, weiss
luminaire en saillie; aluminium, blanc / plastique, blanc

H 30, Ø 500



25W 2900lm

97267 FUEVA 1

surface-mounted luminaire; aluminium, silver / plastic, white
Aufbauleuchte; Alu, silber / Kunststoff, weiss
luminaire en saillie; aluminium, argent / plastique, blanc

H 30, Ø 400



25W 2500lm



9 002759 972660

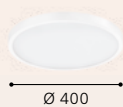

Ø 400



9 002759 972752

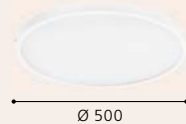

Ø 500



9 002759 972677

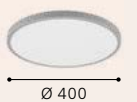

Ø 400



97276



97276

97276 FUEVA 1

surface-mounted luminaire; aluminium, silver / plastic, white
Aufbauleuchte; Alu, silber / Kunststoff, weiss
luminaire en saillie; aluminium, argent / plastique, blanc

H 30, Ø 500

LED

25W

neutral
WHITE

2900lm



Ø 500



94073

LED



94537

LED



94077

LED

94073 FUEVA 1

surface-mounted luminaire; cast metal, white / plastic, white
Aufbauleuchte; Metallguss, weiss / Kunststoff, weiss
luminaire en saillie; fonte métallique, blanc / plastique, blanc

L 170, B 170, H 40



10,9W 1200lm

94077 FUEVA 1

surface-mounted luminaire; cast metal, white / plastic, white
Aufbauleuchte; Metallguss, weiss / Kunststoff, weiss
luminaire en saillie; fonte métallique, blanc / plastique, blanc

L 225, B 225, H 40



16,5W 1700lm

94537 FUEVA 1

surface-mounted luminaire; cast metal, white / plastic, white
Aufbauleuchte; Metallguss, weiss / Kunststoff, weiss
luminaire en saillie; fonte métallique, blanc / plastique, blanc

L 300, B 300, H 40



22W 2600lm



9 002759 940737



9 002759 940775



9 002759 945374





94524



94528



94526



94524 FUEVA 1

surface-mounted luminaire; cast metal, satin nickel / plastic, white
 Aufbauleuchte; Metallguss, nickel-matt / Kunststoff, weiss
 luminaire en saillie; fonte métallique, nickel mat / plastique, blanc

L 170, B 170, H 40



10,9W 1200lm

94526 FUEVA 1

surface-mounted luminaire; cast metal, satin nickel / plastic, white
 Aufbauleuchte; Metallguss, nickel-matt / Kunststoff, weiss
 luminaire en saillie; fonte métallique, nickel mat / plastique, blanc

L 225, B 225, H 40



16,5W 1700lm

94528 FUEVA 1

surface-mounted luminaire; cast metal, satin nickel / plastic, white
 Aufbauleuchte; Metallguss, nickel-matt / Kunststoff, weiss
 luminaire en saillie; fonte métallique, nickel mat / plastique, blanc

L 300, B 300, H 40



22W 2600lm



9 002759 945244



L 170



9 002759 945268



L 225



9 002759 945282



L 300





94074



94538



94078



94074 FUEVA 1

surface-mounted luminaire; cast metal, white / plastic, white
Aufbauleuchte; Metallguss, weiss / Kunststoff, weiss
luminaire en saillie; fonte métallique, blanc / plastique, blanc

L 170, B 170, H 40



12W 1350lm

94078 FUEVA 1

surface-mounted luminaire; cast metal, white / plastic, white
Aufbauleuchte; Metallguss, weiss / Kunststoff, weiss
luminaire en saillie; fonte métallique, blanc / plastique, blanc

L 225, B 225, H 40



18W 2080lm

94538 FUEVA 1

surface-mounted luminaire; cast metal, white / plastic, white
Aufbauleuchte; Metallguss, weiss / Kunststoff, weiss
luminaire en saillie; fonte métallique, blanc / plastique, blanc

L 300, B 300, H 40



24W 2600lm



9 002759 940744



9 002759 940782



9 002759 945381





32444



32446



32445



32444 FUEVA 1

surface-mounted luminaire; cast metal, satin nickel / plastic, white
 Aufbauleuchte; Metallguss, nickel-matt / Kunststoff, weiss
 luminaire en saillie; fonte métallique, nickel mat / plastique, blanc

L 170, B 170, H 40



12W 1350lm

32445 FUEVA 1

surface-mounted luminaire; cast metal, satin nickel / plastic, white
 Aufbauleuchte; Metallguss, nickel-matt / Kunststoff, weiss
 luminaire en saillie; fonte métallique, nickel mat / plastique, blanc

L 225, B 225, H 40



18W 2080lm

32446 FUEVA 1

surface-mounted luminaire; cast metal, satin nickel / plastic, white
 Aufbauleuchte; Metallguss, nickel-matt / Kunststoff, weiss
 luminaire en saillie; fonte métallique, nickel mat / plastique, blanc

L 300, B 300, H 40



24W 2600lm



9 002759 324445



9 002759 324452



9 002759 324469





97264



97282



97273



97264 FUEVA 1

surface-mounted luminaire; aluminium, white / plastic, white
Aufbauleuchte; Alu, weiss / Kunststoff, weiss
luminaire en saillie; aluminium, blanc / plastique, blanc

L 400, B 400, H 30



25W 2500lm

97273 FUEVA 1

surface-mounted luminaire; aluminium, white / plastic, white
Aufbauleuchte; Alu, weiss / Kunststoff, weiss
luminaire en saillie; aluminium, blanc / plastique, blanc

L 500, B 500, H 30



25W 2700lm

97282 FUEVA 1

surface-mounted luminaire; aluminium, white / plastic, white
Aufbauleuchte; Alu, weiss / Kunststoff, weiss
luminaire en saillie; aluminium, blanc / plastique, blanc

L 600, B 600, H 30



27W 3200lm



9 002759 972646



9 002759 972738



9 002759 972820

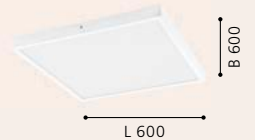



97265



97553



97274



97265 FUEVA 1

surface-mounted luminaire; aluminium, silver / plastic, white
Aufbauleuchte; Alu, silber / Kunststoff, weiss
luminaire en saillie; aluminium, argent / plastique, blanc

L 400, B 400, H 30



97274 FUEVA 1

surface-mounted luminaire; aluminium, silver / plastic, white
Aufbauleuchte; Alu, silber / Kunststoff, weiss
luminaire en saillie; aluminium, argent / plastique, blanc

L 500, B 500, H 30



97553 FUEVA 1

surface-mounted luminaire; aluminium, silver / plastic, white
Aufbauleuchte; Alu, silber / Kunststoff, weiss
luminaire en saillie; aluminium, argent / plastique, blanc

L 600, B 600, H 30

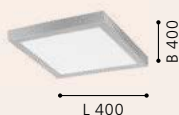



97268



97277



97269



97268 FUEVA 1

surface-mounted luminaire; aluminium, white / plastic, white
Aufbauleuchte; Alu, weiss / Kunststoff, weiss
luminaire en saillie; aluminium, blanc / plastique, blanc

L 400, B 400, H 30



25W 2500lm

97277 FUEVA 1

surface-mounted luminaire; aluminium, white / plastic, white
Aufbauleuchte; Alu, weiss / Kunststoff, weiss
luminaire en saillie; aluminium, blanc / plastique, blanc

L 500, B 500, H 30



25W 2900lm

97269 FUEVA 1

surface-mounted luminaire; aluminium, silver / plastic, white
Aufbauleuchte; Alu, silber / Kunststoff, weiss
luminaire en saillie; aluminium, argent / plastique, blanc

L 400, B 400, H 30



25W 2500lm



9 002759 972684



9 002759 972776

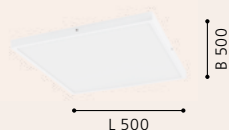

9 002759 972691





97278



97278

97278 FUEVA 1

surface-mounted luminaire; aluminium, silver / plastic, white
Aufbauleuchte; Alu, silber / Kunststoff, weiss
luminaire en saillie; aluminium, argent / plastique, blanc

L 500, B 500, H 30

LED

25W

neutral
WHITE

2900lm



9 002759 972783





96059



96168



96058



IP44

96168 FUEVA 1

surface-mounted luminaire; cast metal, white / plastic, white
Aufbauleuchte; Metallguss, weiss / Kunststoff, weiss
luminaire en saillie; fonte métallique, blanc / plastique, blanc

H 40, Ø 300



96169 FUEVA 1

surface-mounted luminaire; cast metal, white / plastic, white
Aufbauleuchte; Metallguss, weiss / Kunststoff, weiss
luminaire en saillie; fonte métallique, blanc / plastique, blanc

L 300, B 300, H 40



96058 FUEVA 1

surface-mounted luminaire; cast metal, chrome / plastic, white
Aufbauleuchte; Metallguss, chrom / Kunststoff, weiss
luminaire en saillie; fonte métallique, chrome / plastique, blanc

H 40, Ø 300



9 002759 961688

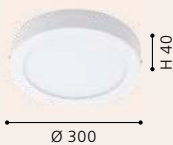

9 002759 961695



9 002759 960582





96059



96169



96059 FUEVA 1

surface-mounted luminaire; cast metal, chrome / plastic, white
Aufbauleuchte; Metallguss, chrom / Kunststoff, weiss
luminaire en saillie; fonte métallique, chrome / plastique, blanc

L 300, B 300, H 40



22 W 2600 lm



9 002759 960599



FUEVA 1

These luminaires are protected against splash water.

Diese Leuchten sind gegen Spritzwasser geschützt.

Les luminaires sont protégées contre les éclaboussures d'eau.

	0	1	2	3
EU	X	X	✓	✓
FR	X	X	X	✓

IP44





94501



94502



94504



94501 POLASSO

ceiling luminaire; aluminium, plastic, black, copper
 Deckenleuchte; Alu, Kunststoff, schwarz, kupfer
 plafonnier; aluminium, plastique, noir, cuivre

H 120, Ø 100



1x 3,3W
 1x
 340lm



9 002759 945015



94504 POLASSO

ceiling luminaire; aluminium, plastic, white, silver
 Deckenleuchte; Alu, Kunststoff, weiss, silber
 plafonnier; aluminium, plastique, blanc, argent

H 120, Ø 100

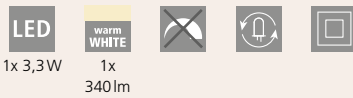

1x 3,3W
 1x
 340lm



9 002759 945046



94502 POLASSO

ceiling luminaire; aluminium, plastic, black, gold
 Deckenleuchte; Alu, Kunststoff, schwarz, gold
 plafonnier; aluminium, plastique, noir, or

H 120, Ø 100

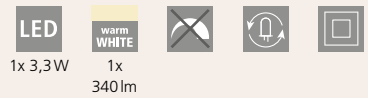

1x 3,3W
 1x
 340lm



9 002759 945022





94503



94633



94633

SURFACE MOUNTED LED LUMINAIRES
DECORATIVE / DÉCORATIF / DÉCORATIF



94503 POLASSO

ceiling luminaire; aluminium, plastic, white, gold
Deckenleuchte; Alu, Kunststoff, weiss, gold
plafonnier; aluminium, plastique, blanc, or

H 120, Ø 100



1x 3,3W
1x
340lm

94633 LASANA

ceiling luminaire; aluminium, steel, white
Deckenleuchte; Alu, Stahl, weiss
plafonnier; aluminium, acier, blanc

H 160, Ø 220



3x 3,3W
3x
240lm



9 002759 945039



Ø 100



9 002759 946333



Ø 220



94496



94498



94497



94496 POLASSO

ceiling luminaire; aluminium, plastic, black, copper
 Deckenleuchte; Alu, Kunststoff, schwarz, kupfer
 plafonnier; aluminium, plastique, noir, cuivre

L 100, B 100, H 120



1x 3,3W
 1x 340lm



9 002759 944964

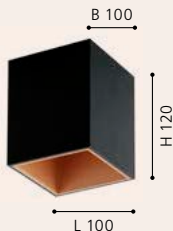

94497 POLASSO

ceiling luminaire; aluminium, plastic, black, gold
 Deckenleuchte; Alu, Kunststoff, schwarz, gold
 plafonnier; aluminium, plastique, noir, or

L 100, B 100, H 120



1x 3,3W
 1x 340lm



9 002759 944971



94498 POLASSO

ceiling luminaire; aluminium, plastic, white, gold
 Deckenleuchte; Alu, Kunststoff, weiss, gold
 plafonnier; aluminium, plastique, blanc, or

L 100, B 100, H 120

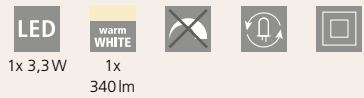

1x 3,3W
 1x 340lm



9 002759 944988





94499



94499 POLASSO

ceiling luminaire; aluminium, plastic, white, silver
 Deckenleuchte; Alu, Kunststoff, weiss, silber
 plafonnier; aluminium, plastique, blanc, argent

L 100, B 100, H 120

1x 3,3W	1x 340lm			

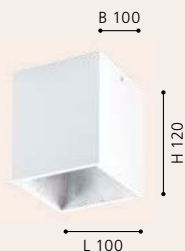

94497



SURFACE MOUNTED LED LUMINAIRES
 DECORATIVE / DÉCORATIF / DEKORATIV / DEKORATIF

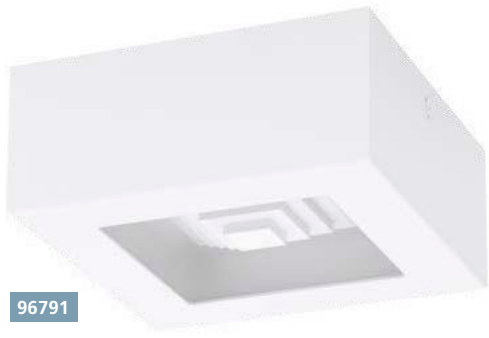

96791

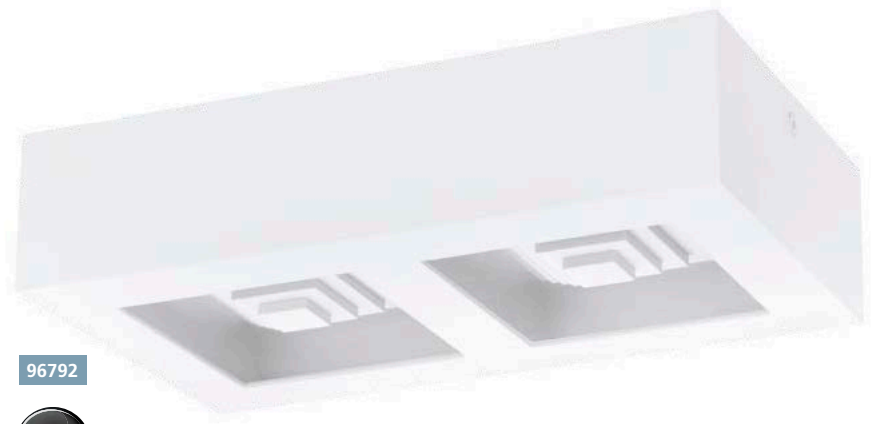

96792

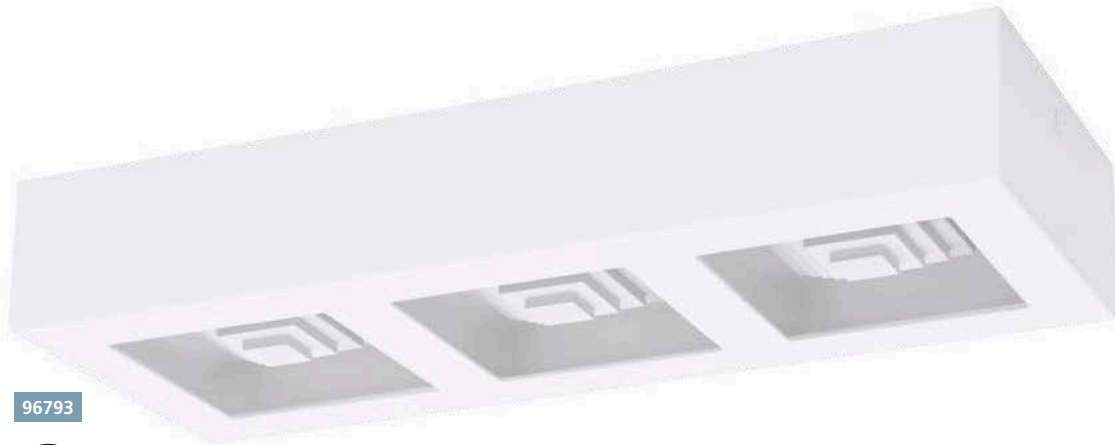

96793



96791 FERREROS

wall / ceiling luminaire; steel, white / plastic, white
 Wand- / Deckenleuchte; Stahl, weiss / Kunststoff, weiss
 applique / plafonnier; acier, blanc / plastique, blanc

L 140, B 140, H 60

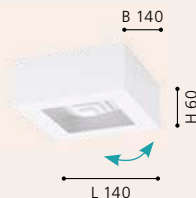

96792 FERREROS

wall / ceiling luminaire; steel, white / plastic, white
 Wand- / Deckenleuchte; Stahl, weiss / Kunststoff, weiss
 applique / plafonnier; acier, blanc / plastique, blanc

L 255, B 140, H 60

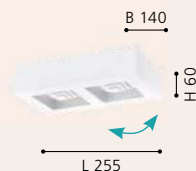
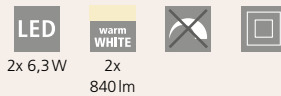

96793 FERREROS

wall / ceiling luminaire; steel, white / plastic, white
 Wand- / Deckenleuchte; Stahl, weiss / Kunststoff, weiss
 applique / plafonnier; acier, blanc / plastique, blanc

L 370, B 140, H 60

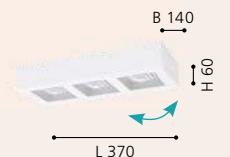
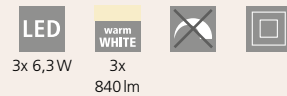

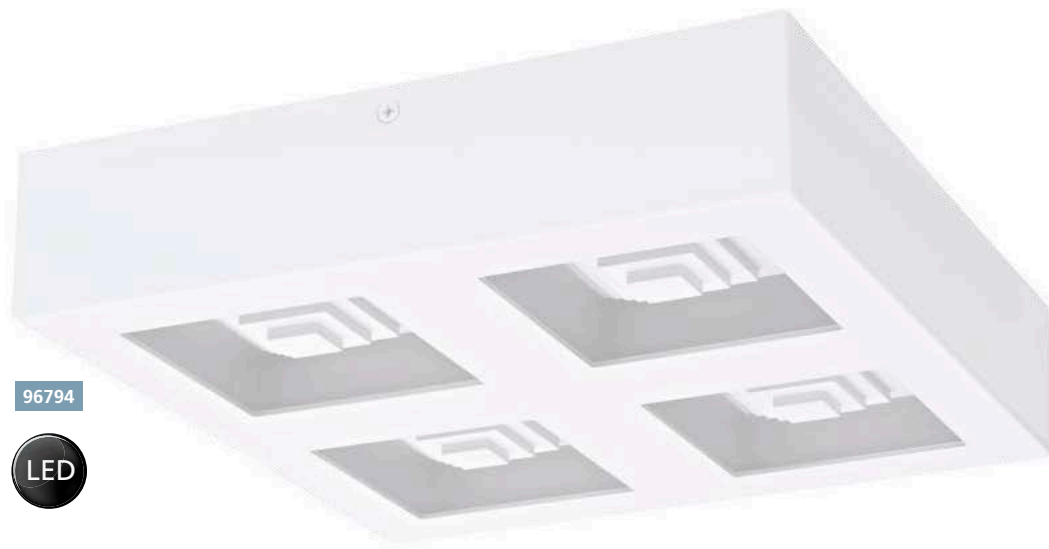

96794



SURFACE MOUNTED LED LUMINAIRES
 DÉCORATIVE / DEKORATIV / DÉCORATIF

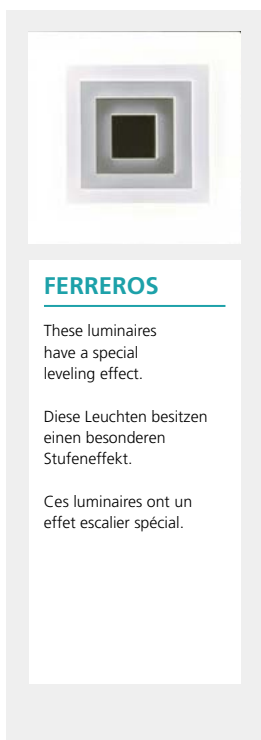

FERREROS

These luminaires have a special leveling effect.

Diese Leuchten besitzen einen besonderen Stufeneffekt.

Ces luminaires ont un effet escalier spécial.



96794

96794 FERREROS

wall / ceiling luminaire; steel, white / plastic, white
 Wand- / Deckenleuchte; Stahl, weiss / Kunststoff, weiss
 applique / plafonnier; acier, blanc / plastique, blanc

L 270, B 270, H 60



4x 6,3W
 4x
 840lm



9 002759 967949

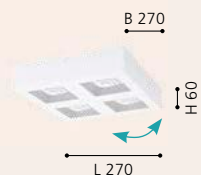



91352



91353



91354



91352 LOKE 1

surface-mounted luminaire; aluminium, steel, brushed aluminium, chrome, black

Aufbauleuchte; Alu, Stahl, alu-gebürstet, chrom, schwarz

luminaire en saillie; aluminium, acier, aluminium brossé, chrome, noir

L 140, B 140, A 85

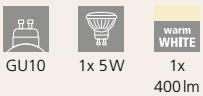

91353 LOKE 1

surface-mounted luminaire; aluminium, steel, brushed aluminium, chrome, black

Aufbauleuchte; Alu, Stahl, alu-gebürstet, chrom, schwarz

luminaire en saillie; aluminium, acier, aluminium brossé, chrome, noir

L 250, B 140, A 85

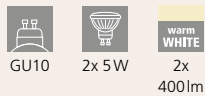

91354 LOKE 1

surface-mounted luminaire; aluminium, steel, brushed aluminium, chrome, black

Aufbauleuchte; Alu, Stahl, alu-gebürstet, chrom, schwarz

luminaire en saillie; aluminium, acier, aluminium brossé, chrome, noir

L 360, B 140, A 85



9 002759 913526

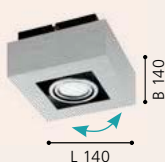

9 002759 913533



9 002759 913540

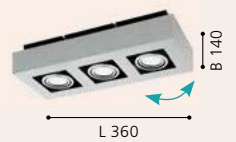



91355



SURFACE MOUNTED LED LUMINAIRES
 DÉCORATIVE / DEKORATIV / DÉCORATIF



91355

91355 LOKE 1

surface-mounted luminaire; aluminium, steel, brushed aluminium, chrome, black

Aufbauleuchte; Alu, Stahl, alu-gebürstet, chrom, schwarz

luminaire en saillie; aluminium, acier, aluminium brossé, chrome, noir

L 250, B 250, A 85



GU10



4x 5W



warm
 WHITE

4x
 400lm



9 002759 913557



LED STRIPS

FLAIR FOR YOUR HOME - LED STRIPS are available in various lengths and for numerous fields of applications. Choose your lighting programme and colour in line with what suits your home and your mood. Thanks to the adhesive tape on the back of the Stripes, you can mount them anywhere in no time, using them as under cabinet lighting in your kitchen or in the living room area.

Let yourself be inspired by EGLO LED STRIPS!



FLAIR IN IHREM ZUHAUSE - LED STRIPS in verschiedenen Längen und für viele Einsatzbereiche werden einfach mit einem Klebeband befestigt. Je nach Stimmung können Sie das entsprechende Lichtprogramm bzw. die geeignete Farbe auswählen – von der indirekten Beleuchtung in der Küchenvitrine bis hin zum Wohnzimmer.

Lassen Sie sich von den EGLO LED STRIPS inspirieren!



CRÉER DES AMBIANCES PERSONNALISÉES - Les LED STRIPS sont disponibles en différentes tailles et peuvent être utilisés pour de nombreuses applications différentes. Il existe des bandeaux de LED adaptés à chaque pièce. Vous pourrez choisir le programme lumineux et la couleur qui correspond le mieux à votre intérieur et votre humeur.

Laissez-vous inspirer par les LED STRIPS EGLO !





97929
97931

97929, 97931, 97925, 97926



97929, 97931

These articles include a remote control.
Bei diesen Artikeln ist eine Fernbedienung inkludiert.
Ces articles comprennent une télécommande.

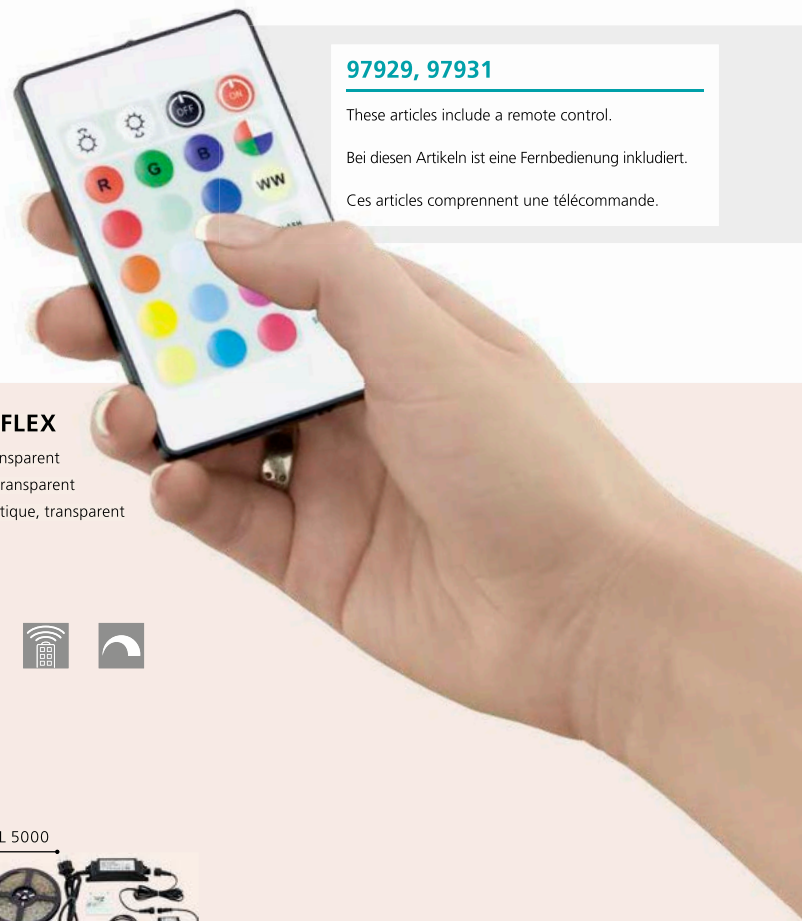

97929 LED STRIPS-FLEX

bar / strip luminaire; plastic, transparent
Leuchtband/-stab; Kunststoff, transparent
bande lumineuse / bâton l; plastique, transparent

97931 LED STRIPS-FLEX

bar / strip luminaire; plastic, transparent
Leuchtband/-stab; Kunststoff, transparent
bande lumineuse / bâton l; plastique, transparent

L 2000, B 10, H 3



L 5000, B 10, H 3



L 2000



A+



L 5000



A+

97925

97926

97925, 97926

These articles include a remote control.

Bei diesen Artikeln ist eine Fernbedienung inkludiert.

Ces articles comprennent une télécommande.

97925 LED STRIPS-FLEX

bar / strip luminaire; plastic, transparent
Leuchtband/-stab; Kunststoff, transparent
bande lumineuse / bâton l; plastique, transparent

L 2000, B 10, H 3



L 2000



97926 LED STRIPS-FLEX

bar / strip luminaire; plastic, transparent
Leuchtband/-stab; Kunststoff, transparent
bande lumineuse / bâton l; plastique, transparent

L 5000, B 10, H 3



L 5000





97928

97927

97927, 97928



97927, 97928

These articles include a remote control.
Bei diesen Artikeln ist eine Fernbedienung inkludiert.
Ces articles comprennent une télécommande.

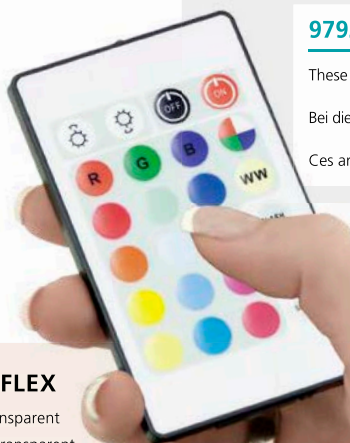

97927 LED STRIPS-FLEX

bar / strip luminaire; plastic, transparent
Leuchtband/-stab; Kunststoff, transparent
bande lumineuse / bâton l; plastique, transparent

L 2000, B 10, H 3



97928 LED STRIPS-FLEX

bar / strip luminaire; plastic, transparent
Leuchtband/-stab; Kunststoff, transparent
bande lumineuse / bâton l; plastique, transparent

L 5000, B 10, H 3





Remote Control

With the aid of the remote control, all LED STRIPS can be dimmed. The "not dimmable" sign shown in the technical info is only valid for utilisation without the remote control.

Mit Hilfe der Fernbedienung können sämtliche LED-STRIPS gedimmt werden. Das „nicht dimmbar“ Zeichen in der technischen Information trifft nur für die Benutzung ohne Fernbedienung zu.

Au moyen de la télécommande, tous les LED STRIPS peuvent être gradués. Le signe « non graduable » dans l'information technique n'est valable que dans le cas d'utilisation sans télécommande.

* This note indicates that the remote control is included with the delivery.

* Bei diesem Hinweis ist die Fernbedienung im Lieferumfang enthalten!

* Avec cette remarque, la télécommande est comprise dans l'étendue de la livraison !

97029

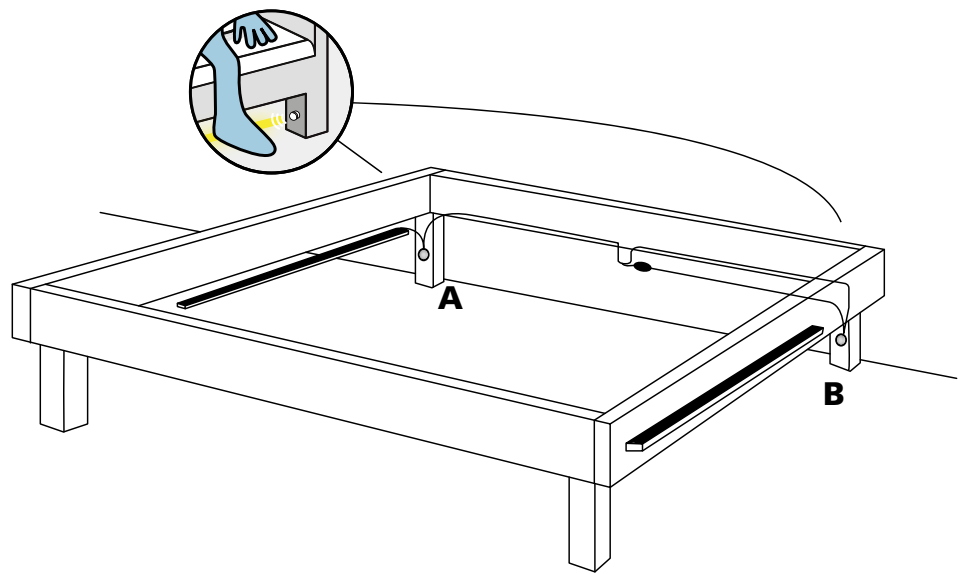

97029 PIDIO

bar / strip luminaire; plastic, white
Leuchtband/-stab; Kunststoff, weiss
bande lumineuse / bâton; plastique, blanc

L 2400, B 8, H 2



36x 0,1W 225lm 36x 0,1W



10



9 002759 970291



97029 PIDIO

This sensor strip is designed to be attached to the side of the bed. Properly placed and connected to the supplied LED strip lights, it will illuminate the base of your bed. The sensor has a 100 degree arc and a 3.5m range. It can be set to automatically activate the light between 30 seconds and 10 minutes.

Diese Sensorleiste ist so konzipiert, dass sie an der Seite des Bettes befestigt werden kann. Richtig platziert und mit den mitgelieferten LED-Streifenleuchten verbunden, wird sie die Basis Ihres Bettes beleuchten. Der Sensor hat einen 100 Grad Bogen und eine 3,5m Reichweite. Er kann so eingestellt werden, dass das Licht zwischen 30 Sekunden und 10 Minuten automatisch aktiviert wird.

Cette barre de capteur est conçu de telle sorte qu'il peut être fixé sur le côté du lit. Correctement placé et connecté à la bande LED fournis, il allume la base du lit. Le capteur a un arc de 100 degrés et une portée de 3,5 m. Il peut être réglé de telle sorte que la lumière est activé entre 30 secondes et 10 minutes automatiquement.

92051



92051 LED STRIPS-DECO

bar / strip luminaire; plastic, white
 Leuchtband/-stab; Kunststoff, weiss
 bande lumineuse / bâton l; plastique, blanc

L 1170



3x 1,6W 330lm
 (3x 20 LED)



92051

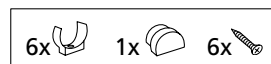
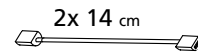
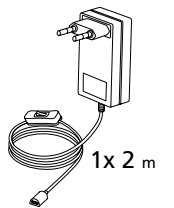

ENERGY EFFICIENCY LABELS

ENERGIEEFFIZIENZ-LABEL

LABEL DE L'EFFICACITÉ ÉNERGÉTIQUE

LED luminaires - are increasingly popular and the demand for energy-efficient solutions is gaining strength. This has resulted in the adoption of several EU regulations prescribing the energy efficiency labelling of light sources and luminaires. We have prepared a brief overview of the new energy labels.

LED Leuchtmittel - sind am Vormarsch, der Ruf nach energieeffizienten Lösungen wird immer größer. In den letzten Jahren wurden daher mehrere EU-Verordnungen verabschiedet, die die Kennzeichnung der Energieeffizienz bei Leuchtmitteln und Leuchten vorschreibt. Hier finden Sie eine kurze Übersicht der neuen Energieeffizienz-kennzeichnung.



Les éclairages LED - gagnent du terrain, la demande de solutions efficaces en énergie ne cesse de croître. C'est la raison pour laquelle plusieurs directives européennes prescrivant le marquage de l'efficacité énergétique des moyens d'éclairage et des lampes ont été promulguées au cours de ces dernières années. Vous trouverez ici un bref aperçu d'ensemble des nouveaux marquages de l'efficacité énergétique.

EEL BUTTONS

bulbs included

inkl. Leuchtmittel | ampoules comprises



incl. highly efficient LED boards
(cannot be replaced by the end consumer)

inkl. hocheffizienter LED Platinen
(können nicht vom Endkonsumenten
ausgetauscht werden)

incl. platines LED très efficaces (ne
peuvent pas être remplacés par le
consommateur final)



incl. highly efficient LED bulbs

inkl. hocheffizienter LED Leuchtmittel
ampoules à LED plus efficaces comprises



incl. efficient LED and/or fluorescent bulbs

inkl. effizienter LED und/oder
Leuchtstoff-Leuchtmittel

ampoules à LED et/ou fluorescentes
efficaces comprises



incl. halogen bulbs

inkl. Halogen-Leuchtmittel
ampoules halogènes comprises

bulbs not included

exkl. Leuchtmittel | ampoules non comprises



The luminaire is compatible with bulbs of
all energy classes.

Die Leuchte ist mit Leuchtmitteln aller
Energieklassen kompatibel.

compatible avec des ampoules de toutes
les classes de l'énergie



The luminaire is only compatible with
energy efficient bulbs.

Die Leuchte ist nur mit energieeffizienten
Leuchtmitteln kompatibel.

compatible uniquement avec des ampoules
économiques en énergie

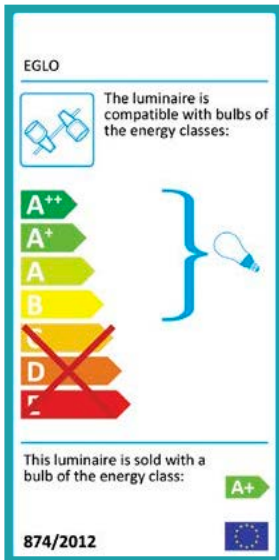

The information in brackets at the centre of the label indicates which bulbs may be used for the luminaire. In this case, the product is only compatible with bulbs with an energy efficiency rating of better than C.

Die Klammer in der Mitte des Labels gibt an, mit welchen Leuchtmitteln die Leuchte kompatibel ist. In diesem Fall dürfen nur Leuchtmittel verwendet werden, deren Energieklasse effizienter als C ist.

La parenthèse au milieu du label indique les moyens d'éclairage avec lesquels la lampe est compatible. Il est seulement permis dans ce cas d'utiliser des moyens d'éclairage dont la classe d'énergie présente une efficacité supérieure à C.

If bulbs are included with the luminaire, their energy classes are indicated at the bottom of the label.

Falls Leuchtmittel inkludiert sind, wird deren Energieklasse im unteren Teil des Labels angegeben.

Si des moyens d'éclairage sont inclus, leur classe énergétique est indiquée dans la partie inférieure du label.



This label indicates that no bulbs are included with the luminaire. Consumers are free to choose their preferred bulb within the indicated energy classes.

Dieses Label wird verwendet, wenn die Leuchte ohne Leuchtmittel ausgeliefert wird. Der Kunde kann selber entscheiden, welches Leuchtmittel der angegebenen Klassen verwendet wird.

Ce label est utilisé lorsque la lampe est livrée sans ampoules. Le client peut décider lui-même quel ampoule des classes indiquées est utilisé.

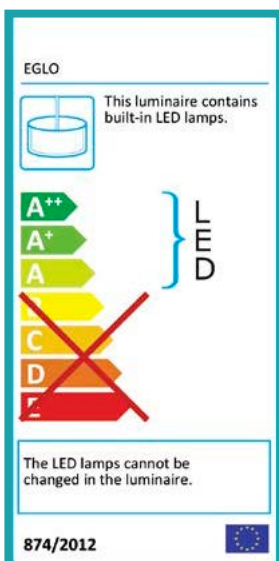

This label indicates that the luminaire is sold with built-in LED lamps that cannot be replaced by the consumer himself.

Dieses Label wird verwendet, wenn Leuchten mit LED-Modulen verkauft werden, die vom Endkunden nicht selbstständig ausgetauscht werden können.

Ce label est utilisé lorsque des lampes sont vendues avec des modules LED ne pouvant pas être changés par les clients finaux eux-mêmes.

EGLO WORLDWIDE

EGLO WELTWEIT

EGLO DANS LE MONDE



 **HEADQUARTERS**
EGLO LEUCHTEN GMBH
Heiligkreuz 22
A-6136 PILL
T: +43 5242 6996 0 | F: +43 5242 6996 972
E: info-austria@eglo.com

 **CANADA**
EGLO CANADA INC.
20700 Route Transcanadienne
Baie-D'Urfé, Québec | H9X 4B7
T: +1 514 457 5483 | F: +1 514 457 5487
E: info-canada@eglo.com

 **CZECH REPUBLIC**
EGLO CZ+SK s.r.o.
Náchodská 2479/63
CZ-193 00 PRAHA 9 Horní Počernice
T: +420 281 924 163 | F: +420 281 925 205
E: info-czechrepublic@eglo.com

 **AUSTRALIA**
EGLO LIGHTING AUSTRALIA
5/339 Archerfield Road
Richlands | Queensland 4077
T: +61 7 3375 1413 | F: +61 7 3375 1412
E: info-australia@eglo.com

 **CHILE - SANTIAGO**
EGLO CHILE ILUMINACION LTDA.
Av. Américo Vespucio 1930
Conchalí - SANTIAGO DE CHILE
T: +56 2 595 2222
E: info-chile@eglo.com

 **DENMARK**
EGLO DANMARK A/S
Agerbakken 20
DK-8362 Hørning
T: +45 70 22 55 11 | F: +45 70 22 55 21
E: info-denmark@eglo.com

 **BELGIUM**
EGLO BELGIUM B.V.B.A.
Antwerpsesteenweg 247 | B-2950 Kapellen
Visit Address: Innovatiepark 20 |
4906 AA OOSTERHOUT (NL)
T: +32 3 250 60 80 | F: +32 3 219 80 67
E: info-belgium@eglo.com

 **CHINA**
DONGGUAN EGLO LIGHTING COMMERCIAL CO LTD
No.1 | Shangqiao Industrial Road | Shangqiao,
Dongcheng District
DONGGUAN CITY, GUANZHOU PROVINCE | CHINA
T: +86 769 2203 3866 | F: +86 769 2203 6866
E: info-china@eglo.com

 **ESTONIA**
MOODNE VALGUSTUS AS
Rävala pst. 7
EE-10143 TALLINN
T: +372 667 6670 | F: +372 631 3195
E: info-global@eglo.com

 **BOSNIA-HERZEGOVINA**
EGLO RASVJETA BH D.O.O.
Ormanica bb
BIH-76250 GRADACAC
T: +387 35 86 85 00 | F: +387 35 82 44 41
E: Info-Bosnia-Herzegovina@eglo.com

 **COLOMBIA**
EGLO COLOMBIA ILUMINACION SAS
AUTOPISTA NORTE KM 19 COSTADO LOTE 30
BOGOTÁ - CHIA
T: +57 (1) 744 2339
E: info-global@eglo.com

 **FINLAND**
EGLO FINLAND OY
Malminraititi 17A
00700 Helsinki
T: +358 20 7649 820 | F: +358 20 7649 821
E: info-finland@eglo.com

 **BRAZIL**
EGLO DO BRASIL LUMINÁRIAS LTDA.
Villa Lobos Office Park | Av. Queiroz Filho, 1.700,
Torre D, Sala 1, Vila Hamburguesa - São Paulo - Brasil
CEP: 05319-000, T: +55 11 4193 6980
F: +55 11 2337-3921 | E: Info-Brazil@eglo.com

 **COSTA RICA**
EGLO Costa Rica, Centro Comercial Calle Real local #8
Guachipilín de Escazú de la sucursal del BAC
San Jose 800 metros al norte San Jose Costa Rica.
T: +506-2289-4690, +506-2100-6384
E: Info-CostaRica@eglo.com

 **FRANCE**
EGLO FRANCE LUMINAIRE SARL
Z.A. Jeune Bois | 2 Rue de la Martinique
F-68274 WITTENHEIM
T: +33 389 6250 30 | F: +33 389 6250 49
E: info-france@eglo.com

 **BULGARIA**
EGLO BULGARIA EOOD
Main Road Burgas-Sofia, 5th kilometer,
Building KACHIKA, 8000 BOURGAS, Bulgaria
T: +359 56 960 403 | F: +359 56 53 05 95
E: info-bulgaria@eglo.com

 **CROATIA**
EGLO RASVJETA D.O.O.
Josipa Loncara 3
HR-10000 ZAGREB
T: +385 1 379 40 62 | F: +385 1 379 41 04
E: info-croatia@eglo.com

 **GERMANY**
EGLO LEUCHTEN HANDELS GMBH
Kleinbahnstr. 35
D-59759 ARNSBERG
T: +49 2932 6269 0 | F: +49 2932 6269 39
E: info-germany@eglo.com



GREECE
EGLO HELLAS A.E.
Sykias 2 and parodos dekeleias
ACHARNAI, GR-13679
T: +30 210 240 77 10 | F: +30 210 240 07 29
E: info-greece@eglo.com



GREAT BRITAIN
EGLO UK LTD.
Unit 12 Cirrus Park, Lower Farm Road, Moulton Park
Industrial Estate, NORTHAMPTON NN3 6UR
T: +44 1604 790 986 | F: +44 1604 670 282
E: info-greatbritain@eglo.com



HUNGARY - PRODUCTION & LOGISTICS
EGLO MAGYARORSZAG KFT.
Fő út. 155
H-3060 PASZTO
T: + 36 32 560 050 | F: +36 32 560 040
E: info-hungary@eglo.com



INDIA
EGLO INDIA PRIVATE LIMITED
A-307 Ansal Chamber-1, 3 Bhikaji Cama Place,
New Delhi-110066
T: +91 981 108 2205 | F: +91 999 961 0450
E: info-india@eglo.com



ITALY
EGLO ITALIANA S.R.L.
Via Giotto, 4
I-31021 MOGLIANO VENETO (TV)
T: +39 041 45 66 232/245/251 | F: +39 041 45 74 066/071
E: info-italy@eglo.com



KAZAKHSTAN
EGLO KAZAKHSTAN LLP
Al-Farabi ave 7, Nurly-Tau Business Center, bld. 5A,
office 113, 050059, Almaty, Kazakhstan
mobile: +7 701 031 00 00 | T: +7 727 293 25 20, 311 52 90(91)
F: +7 727 293 25 24 | E: info-kazakhstan@eglo.com



KOSOVO
EGLO KOSOVO LLC
Lugisht e qytetit pn
20000 PRIZREN- KOSOVO
T: +377 44 2166 87 | Shop: +381 29 2442 84
E: info-kosovo@eglo.com



LEBANON
EGLO Lebanon S.A.R.L
Damascus Road, Graizy Building - Basement No. 1
Aley city, Lebanon
T: +961 555 9125 | T: +961 555 9126
E: info-global@eglo.com



LITHUANIA
MOODNE VALGUSTUS AS
Rävala pst. 7
EE-10143 TALLINN
T: +370 652 49923 | T: +372 667 6670
E: info-lithuania@eglo.com



MAGYARORSZÁG – ÉRTÉKESÍTÉS
EGLO LUX KFT.
Fő út. 143/A
H-2120 DUNAKESZI
T: +36 27 341 353 | F: +36 27 341 409
E: info-hungary@eglo.com



MALAYSIA
EGLO ASIA SDN BHD
No. 13, Jalan Pelukis U1/46B, Temasya 18, Glenmarie,
40150 Shah Alam, Selangor Darul Ehsan, Malaysia
T: +6011 1050 2336 | F: +603 5567 9415
E: info-malaysia@eglo.com



MEXICO
EGLO MÉXICO ILUMINACIÓN S DE RL DE CV
Prolongación Avenida López Mateos Sur N°3561,
Fraccionamiento Los Gavilanes.
C.P. 45645, Tlalajmulco de Zúñiga, Jalisco, México
T: +52 33 3687 20 95 | E: info-mexico@eglo.com



MIDDLE EAST
EGLO LIGHTING MIDDLE EAST FZE
P.O. BOX 262073, LOB 6, OFFICE G18
JEBEL ALI, DUBAI, UAE
T: +97 148810080 | F: +97 148810081
E: info.me@eglo.com



MOROCCO
EGLO AFRICA
219 Bd Med Zerkouni. Suite: 67
20330 CASABLANCA | Morocco
T: +212 522 988 025
E: info.africa@eglo.com



THE NETHERLANDS
EGLO VERLICHTING NEDERLAND B.V.
Innovatiepark 20
4906 AA OOSTERHOUT (NBR)
T: +31 162 48 28 30 | F: +31 162 48 28 40
E: Info-Netherland@eglo.com



NORWAY
ELEKTRO-ARMATUR a.s
Bjørnerudveien 18
N-1266 OSLO
T: +47 2262 9000 | F: +47 2262 9040
E: info-norway@eglo.com



PERU
EGLO Peru SAC
Avda. Primavera N° 1419 Distrito de Santiago de Surco
Provincia y Departamento de Lima.
T: +51 1 633 0655
E: info-peru@eglo.com



PHILIPPINES
EGLO Lighting Pilipinas Corp.
4/F One E-Com Center Building, Ocean Drive, Mall
of Asia Complex, Pasay City 1300 Philippines
T: +63 2 737 9419
E: info-global@eglo.com



POLAND
EGLO POLSKA SP. Z.O.O.
Ul. Pulawska 479
02-844 WARSZAWA
T: +48 22 644 57 55 | F: +48 22 644 89 82
E: info-poland@eglo.com



PORTUGAL
EGLO PORTUGAL ILUMINAÇÃO, LDA
Rua Fonte Parada, 125
PT-4595-434 SEROA-PAÇOS DE FERREIRA
T: +351 255 890 000 | F: +351 255 892 346
E: info-portugal@eglo.com



ROMANIA
EGLO ROMANIA PRODEXIM SRL.
Str. Atomistilor nr. 1D
R-077125 MAGURELE - ILFOV - ROMANIA
T: +40 314 250 902 | F: +40 314 250 899
E: info-romania@eglo.com



RUSSIA
EGLO LIGHTING LLC
Varshavskoe shosse 35 | Building 1
RU-117105 | MOSCOW
T: +7495 789 4311 | F: +7495 789 4312
E: info-russia@eglo.com



SERBIA
EGLO RASVETA DOO
Stefana Prvovenčanog 28
11000 BEOGRAD | SRBIJA
T: +381 11 3981 366 | F: +381 11 3981 389
E: info-serbia@eglo.com



SLOVAKIA
EGLO CZ+SK s.r.o
Náchodská 2479/63
CZ-193 00 PRAHA 9 Horní Pocernice
T: +421 313 211 551 | F: +421 313 211 556
E: info-slovakia@eglo.com



SLOVENIA
EGLO RASVJETA D.O.O.
Josipa Lončara 3
HR-10000 ZAGREB
T: +386 158 093 18
E: info-slovenia@eglo.com



SPAIN
EGLO ESPANA ILUMINACION S.L.
Avda. de Castilla 1 (Edf. Best Point) 2º-16A
San Fernando de Henares, E-28830 MADRID
T: +34 91 677 9044 | F: +34 91 677 0304
E: info-spain@eglo.com



SWEDEN
EGLO SVERIGE AB
Honungsgatan 3
S-432 48 VARBERG
T: +46 340 623 505 | F: +46 340 623 605
E: info-sweden@eglo.com



SWITZERLAND
EGLO SCHWEIZ AG
Seetalstraße 142
CH-6032 EMMEN
T: +41 41 268 69 59 | F: +41 41 268 69 58
E: info-switzerland@eglo.com



THAILAND
EGLO Thailand
759 NapLab Building 4th Fl. Room 405
Soi Chulalongkorn 6 Bunthudthong Road
Wangmai, Pathumwan, Bangkok 10330
Thailand



TURKEY
Eglo Aydınlatma ithalat ihracat Ltd. Şti.
Eyüp Sultan Mah. Sekmen Cad. No:18/2
34855 SAMANDIRA, SANCAKTEPE / İSTANBUL
T: +90 216 311 09 -02 / -03 / -04 | F: +90 216 311 09 -05
E: info-turkey@eglo.com



USA
EGLO USA, INC.
3640 Royal South Parkway
ATLANTA, GEORGIA 30349
T: +1 404 477 5601 | F: +1 404 393 7053
E: info-usa@eglo.com



UKRAINE
EGLO UKRAINE LTD
bulv. Vatslav Havel 6/7A
UA-03680 KIEV
T: +38 044 463 98 41 | F: +38 044 468 84 67
E: info-ukraina@eglo.com

HOW TO READ

ERKLÄRUNG
COMMENT LIRE

DIMENSIONS DIMENSIONEN DIMENSIONS

all dimensions in mm | alle Größen in mm | toutes dimensions en mm

L = length | Länge | longueur

B = width | Breite | largeur

H = height | Höhe | hauteur

∅ = diameter | Durchmesser | diamètre

A = projection length | Ausladung | amplitude

ET = installation depth | Einbautiefe | profondeur utile

Base = base dimensions | Sockelmaße | dimensions de base

Attention! The dimensions relate solely to the sizes of the luminaire. Any air spaces that would be relevant for a safe operating of the lamp were not considered.

Achtung! Die Größen beziehen sich nur auf die Abmessungen der Leuchte. Etwaige Lufträume, die für einen sicheren Betrieb der Leuchte notwendig sind, werden nicht berücksichtigt.

Attention! Les dimensions se réfèrent à la taille de la lampe seulement. Espacements éventuels, que seraient importants pour une opération de la lampe sans danger, n'ont pas été considérés.

BUTTONS BUTTONS BOUTONS

EEL bulbs not included | Leuchtmittel exklusive | ampoules non comprises



EEL bulbs included | Leuchtmittel inklusive | ampoules comprises

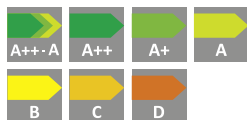

p.184-185

Bulb included | Leuchtmittel inkludiert | ampoules inclus



RECESSED LUMINAIRES LOW VOLTAGE LED
STANDARD

94041 FUEVA 1
recessed luminaire; cast metal, white / plastic, white
Einbauleuchte; Metallguss, weiss / Kunststoff, weiss
luminaire encastrable; fonte métallique, blanc / plastique, blanc

∅ 85, ET 30

LED 2,7W 300lm ∅73

9 002759 940416

A++

94047 FUEVA 1
recessed luminaire; cast metal, white / plastic, white
Einbauleuchte; Metallguss, weiss / Kunststoff, weiss
luminaire encastrable; fonte métallique, blanc / plastique, blanc

∅ 120, ET 30

LED 5,5W 600lm ∅108

9 002759 940478

A+

94055 FUEVA 1
recessed luminaire; cast metal, white / plastic, white
Einbauleuchte; Metallguss, weiss / Kunststoff, weiss
luminaire encastrable; fonte métallique, blanc / plastique, blanc

∅ 170, ET 30

LED 10,9W 1200lm ∅155

9 002759 940553

A+

106 | RECESSED & SURFACE LUMINAIRES

ARTICLE NUMBER
ARTIKELNUMMER
NUMÉRO D'ARTICLE

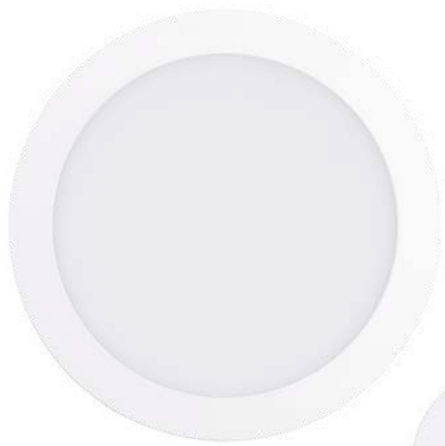

94063 FUEVA 1

recessed luminaire; cast metal, white / plastic, white
Einbauleuchte; Metallguss, weiss / Kunststoff, weiss
luminaire encastrable; fonte métallique, blanc / plastique, blanc

Ø 225, ET 30



94732 FUEVA 1

recessed luminaire; cast metal, white / plastic, white
Einbauleuchte; Metallguss, weiss / Kunststoff, weiss
luminaire encastrable; fonte métallique, blanc / plastique, blanc

Ø 85, ET 30



SERIES NAME
SERIENNAME
NOM DE LA SÉRIE

SPARE PARTS
ERSATZTEILE
PARTS DE REMPLACEMENT

If spare parts for product are available they are marked on the photograph with their corresponding article number.

Wenn zu einem Produkt Ersatzteile vorhanden sind, werden diese in der Abbildung mit der entsprechenden Artikelnummer markiert.

Si un produit a des parts de remplacement, elles sont marquées avec le numéro d'article dans la photo.

DESCRIPTION
BESCHREIBUNG
DESCRIPTION

The product description is composed as follows: luminaire type; enclosure material, enclosure colour / glass or shade material, glass or shade colour

Die Produktbeschreibung setzt sich wie folgt zusammen: Leuchtenart; Gehäusematerial, Gehäusefarbe / Schirm- bzw. Glasmaterial, Schirm- bzw. Glasfarbe

La description du produit est composée comme suit: type de luminaire; matériel de boîtier, couleur de boîtier / matériel de verre ou abat-jour, couleur de verre ou abat-jour

PICTOGRAMMES
PIKTOGRAMME
PICTOGRAMMES

Technical details are represented as pictogrammes. An overview over all pictograms can be found on the next pages.

Technische Details werden als Piktogramme dargestellt. Eine Übersicht über alle Piktogramme finden Sie auf den nächsten Seiten.

Les détails techniques sont représentés sous forme de pictogrammes. Vous trouverez un aperçu de tous les pictogrammes dans les pages suivantes.

SKETCHES
SKIZZEN
CROQUIS

The sketches state the most meaningful dimensions. If a product is adjustable by will, a turquoise arrow marks this function and only the maximum dimensions are indicated.



















Die Bemessung der Skizzen umfasst jeweils die aussagekräftigsten Größen. Bei verstellbaren Produkten kennzeichnet ein türkiser Pfeil diese Funktion und nur die maximalen Größen werden angegeben.

Les dimensions des croquis comprennent les plus représentatives. Si un produit est réglable au choix, une flèche turquoise affiche cette fonction et rien que les dimensions maximales sont indiquées.





















































LEGEND

PICTOGRAM PIKTOGRAMME PICTOGRAMME

SOCKETS FASSUNGEN DOUILLES

 LED	 G4	 G53
 2G7	 G5	 GU5,3 / MR16
 2G11	 G9	 GU10
 2GX13	 G10Q	 GX53
 E14	 G13	 GY6,35
 E27	 G23	 R7s

BULBS LEUCHTMITTEL AMPOULES

 E14 / C35	 E27 / A60 Halogen	 E27 / E140 Filament
 E14 / C35f	 E27 / R63 Halogen	 E27 / PS160 Filament
 E14 / D45	 E27 / A60 LED	 E27 / T30 Filament
 E14 / C35f LED	 E27 / A60 Filament	 E27 / T32 Filament
 E14 / D45 Halogen	 E27 / A65 LED	 G4 / T9
 E14 / C35 Halogen	 E27 / A75 Filament	 G4 / LT9
 E14 / T22	 E27 / G45 LED	 G4 / LT14
 E14 / C35 Filament	 E27 / G45 Filament	 G9
 E14 / C37 Filament	 E27 / G80 Filament	 G9 LED
 E14 / C35f Filament	 E27 / G95	 GU10
 E14 / C37f Filament	 E27 / G95 Filament	 GU10 LED
 E14 / P45 LED	 E27 / G125	 GU10 SMD LED
 E14 / P45 Filament	 E27 / G95 LED	 GX53 / LF75
 E14 / P50	 E27 / G200 Filament	LED LED board / LED Platine / LED bord
 E14 / ST48 Filament	 E27 / R63 LED	 MR16
 E14 / ST64 Filament	 E27 / ST48 Filament	 MR16 LED
 E14 / T20 LED	 E27 / ST64 Filament	 R7s / 78mm
 E27 / A60	 E27 / B80 Filament	 R7s / 118mm
 E27 / G90	 E27 / BR150 Filament	 R7s / 78mm LED
 E27 / QR63	 E27 / DP165 Filament	 R7s / 118mm LED

LIGHT COLOUR & LUMEN
LICHTFARBE & LUMEN
COULEUR LUMINEUX & LUMEN

The colours of the LED are represented as pictogrammes (see below), their luminous flux directly beneath. The luminous flux is quoted in lumen and describes the amount of light generated by the LED. The higher the value, the brighter is the lamp. Lumens are LED boards and are the light measurement value in bulbs.

Die Farben der LED werden als Piktogramm (siehe unten) dargestellt, deren Lichtstrom direkt darunter. Der Lichtstrom wird in Lumen gemessen und gibt die erzeugte Lichtmenge der LED an. Je höher der Wert, desto heller das Produkt. Lichtstromangaben (Lumen) sind Platinen- bzw. Leuchtmittelwerte.

Les couleurs de LED ont représentés sous forme de pictogrammes, leur flux lumineux directement en dessous. L'unité de flux lumineux est le lumen et il mesure la quantité de lumière générée par les LED. Plus la valeur est élevée, plus la lampe est lumineuse. Les lumens sont l'unité de mesure de l'intensité lumineuse des ampoules et des panneaux led intégrés.

	RGB RGB RGB		RGB + tunabel white RGB + tunabel white RGB + tunabel white
	RGB + white RGB + weiß RGB + blanc		tunable white tunable white tunable white
	RGB + warmwhite RGB + warmweiß RGB + blanc chaud		warm white warmweiß blanc chaud
	RGB + coldwhite RGB + kaltweiß RGB + blanc froid		cold white kaltweiß blanc froid
	RGB + neutralwhite RGB + neutralweiß RGB + blanc neutral		neutral white neutralweiß blanc neutre

SWITCHES & SENSORES
SCHALTER & SENSOREN
INTERRUPTEUR & CAPTEURS

	incl. cable & plug inkl. Kabel & Stecker câble & connecteur inclus		pedal switch Trittschalter interrupteur à pied		swedish plug Stecker Schweden connecteur swede
	internal dimmer eingebauter Dimmer variateur intégré		cable switch Kabelschalter interrupteur à câble		"Touch me" ON/OFF "Touch me" EIN/AUS "Touch me" ON/OFF
	button switch Druckknopf interrupteur de pression		incl. cable & plug transformer inkl. Kabel & Stecktransformator câble & transformateur à prise		"Touch me" ON/OFF & dimm "Touch me" EIN/AUS & Dimmen "Touch me" ON/OFF & graduable
	function switch Funktionsschalter interrupteur fonction		remote control Fernbedienung télécommande		pull switch Zugschalter interrupteur à bascule
	rocker switch Wippschalter interrupteur à bascule		Day & Night Sensor Tag & Nacht Sensor sensor jour & nuit		Timer - automatic on/off Zeitschaltuhr - automatisches Ein- & Ausschalten minuterie - peut être éteint et allumé automatiquement
	pedal dimmer Trittdimmer variateur à pied		sensor Sensor sensor		

FUNKTIONEN & KOMFORT
FUNKTIONEN & KOMFORT
FONCTIONS & CONFORT

	incl. battery inkl. Akku incl. pile		cutout (in mm) Ausschnitt (in mm) perçage du panneau (en mm)		shortable kürzbar réductible
	incl. battery inkl. Batterie incl. pile		dimmmable dimmmbar graduabile		Voltage Volt Voltage
	battery specifications Batteriespezifikationen spécifications des piles		not dimmmable nicht dimmmbar ne pas graduabile		Watt
	beam angle Ausstrahlwinkel angle de rayonnement		replaceable LED austauschbare LED LED remplaçables		
	corner mount possible Eckmontage möglich montage en coin possible		loadable in kg belastbar in kg chargeable en kg		
	CRI Colour Rendering Index		packaging / delivery unit Verpackungs- / Liefereinheit unité d'emballage / de livraison		

PROTECTION CLASS
SCHUTZKLASSE
CLASSE DE PROTECTION

The protection class indicates to what extent the lamp is protected against electric shock. All lamps in this catalogue are at least protected with the protection class 1 - a higher class is specified in the information box of the respective lamp.

Die Schutzklasse gibt an, inwiefern ein Produkt gegen einen elektrischen Schlag gesichert ist. Alle Leuchten in diesem Katalog sind mit mindestens Schutzklasse 1 gesichert, bei höheren Klassen wird das Symbol im Infokasten der Leuchte angegeben.

La classe de protection indique, dans quelle mesure la lampe est protégée contre les chocs électriques. Tous les lampes dans ce catalogue sont protégées au moins avec la classe 1 - une classe plus élevée est indiquée dans l'information de la lampe.

	protection class 1: protective earthing Schutzklasse 1: Schutzerdung classe de protection 1: prise de terre		protection class 2: protective insulation Schutzklasse 2: Schutzisolierung classe de protection 2: double isolation ou renforcée		protection class 3: protective low voltage Schutzklasse 3: Schutzkleinspannung classe de protection 3: très basse tension de sécurité
--	---	--	--	--	---

PROTECTION RATING
SCHUTZGRAD
INDICE DE PROTECTION

The protection rating ensures the operational safety of luminaires. The first number specifies the extent of the protection against the ingress of foreign bodies; the second number identifies the humidity protection grade. All luminaires in this catalogue are at least protected with the rating IP20 - a higher rating is specified in the information box of the luminaire.

Der Schutzgrad gewährleistet die Betriebssicherheit von Leuchten. Die erste Ziffer des IP Grades beschreibt den Schutzzumfang gegen das Eindringen von Fremdkörpern, die zweite Ziffer informiert über den Grad des Feuchtigkeitsschutzes. Alle Leuchten in diesem Katalog sind mit mindestens Schutzgrad IP20 gesichert, bei höheren Graden wird das Symbol im Infokasten der Leuchte angegeben.

L'indice de protection assure la sécurité opérationnelle des luminaires. Le premier chiffre indique à quel point la protection est efficace contre l'insertion de corps étrangers; le second chiffre indique quant à lui le degré de protection par rapport à l'humidité. Tous les luminaires dans ce catalogue sont protégés au moins avec l'indice IP20 - un indice plus élevé est indiqué dans l'information d'article.

	IP33		IP44		IP54		IP65		IP67
--	------	--	------	--	------	--	------	--	------

REGISTER

SERIES NAMES
SERIENNAMEN
NOME DE PRODUITS

NAME NAME NOM	PAGE SEITE PAGE
ACCESS REMOTE	36
CHANGO	132
CONNECT REMOTE	14
FERREROS	170-171
FIOBBO	130-131
FUEVA 1	106-121,124-129,148-165
FUEVA-A	41
FUEVA-C	18-26
LASANA	167
LED STRIP-DECO	181
LED STRIP-FLEX	176-178
LED-STRIP-A	42
LOKE 1	172-173
MARGO-LED	99
PENETO	136,138-141
PIDIO	180
PINEDA	80-85,96-98
PINEDA 1	100-101
POLASSO	166-169
RANERA	102
RONZANO 1	122
SALABATE	94-95
SALICETO	86-93
SALOBRENA 1	48-51,58-59
SALOBRENA 2	68-71
SALOBRENA-A	38-39
SALOBRENA-C	16-17
SALOBRENA-M	60
SALOBRENA-RGBW	72
SARSINA	64-67
SARSINA-A	36-37
SARSINA-C	14-15
SARTIANO	78
STRIP-C	28
TEDO	142-143,145
TEDO 1	144-145
TURCONA	54-55
ZARATE	103

REGISTER

ARTICLE NUMBER

ARTIKELNUMMER

NUMÉROS D'ARTICLE

NUMBER NUMBER NUMÉRO	PAGE SEITE PAGE	NUMBER NUMBER NUMÉRO	PAGE SEITE PAGE	NUMBER NUMBER NUMÉRO	PAGE SEITE PAGE	NUMBER NUMBER NUMÉRO	PAGE SEITE PAGE	NUMBER NUMBER NUMÉRO	PAGE SEITE PAGE	NUMBER NUMBER NUMÉRO	PAGE SEITE PAGE
31671	108	94054	118	94537	156	96163	126	97277	162	98243	86
31672	112	94055	106	94538	158	96164	126	97278	163	98244	86
31673	116	94056	124	94633	167	96165	126	97279	152	98245	87
31674	120	94058	110	94732	107	96166	127	97282	160	98246	87
31675	109	94061	114	94733	115	96168	164	97426	99	98292	41
31676	113	94062	118	94734	109	96169	164	97427	99	98293	41
31677	117	94063	107	94735	117	96406	125	97428	99	98295	42
31678	121	94064	124	95276	120	96407	125	97501	64	98296	42
31682	142	94066	111	95357	144	96408	125	97502	64	98297	38
31683	142	94068	115	95359	145	96616	145	97503	64	98301	90
31688	142	94069	119	95465	112	96617	145	97504	66	98302	92
31689	143	94071	148	95466	120	96662	16	97505	66	98303	90
32441	151	94072	150	95467	112	96663	16	97552	153	98304	92
32442	151	94073	156	95817	96	96664	17	97553	161	98305	91
32443	151	94074	158	95818	96	96668	18	97591	130	98306	93
32444	159	94075	148	95819	96	96669	22	97592	130	98307	91
32445	159	94076	150	95821	97	96671	22	97593	130	98308	93
32446	159	94077	156	95822	97	96672	23	97594	131	98418	60
32732	14	94078	158	95823	97	96673	23	97629	16	98419	60
32733	28	94235	136	95841	82	96676	20	97925	177	98471	88
32737	18	94236	136	95843	83	96677	24	97926	177	98472	88
32738	18	94237	136	95844	82	96678	24	97927	178	98473	88
32741	28	94239	138	95846	83	96679	25	97928	178	98474	89
32753	20	94241	139	95847	80	96681	25	97929	176	98475	54
32754	20	94242	138	95848	80	96791	170	97931	176	98476	54
32811	59	94243	140	95849	80	96792	170	97958	14	98477	54
32812	58	94262	141	95851	81	96793	170	97959	14	98478	55
32813	58	94264	141	95852	81	96794	171	97961	15	98479	55
32881	19	94405	140	95853	81	96891	68	98025	59	98485	65
32882	21	94406	138	95854	84	96892	68	98026	69	98521	122
32896	78	94407	139	95855	84	96893	68	98027	71	98522	122
33107	72	94408	139	95856	84	96894	69	98036	70	98559	26
33108	72	94496	168	95857	85	96901	103	98037	70	98561	26
33199	36	94497	168	95858	85	96902	103	98038	70	98566	15
61355	50	94498	168	95859	85	97027	102	98039	71	98607	86
61358	50	94499	169	95887	98	97028	102	98089	17	98609	90
61359	51	94501	166	95888	98	97029	180	98129	58	98611	92
61361	51	94502	166	95889	98	97079	132	98201	38		
61489	50	94503	167	95917	100	97262	152	98203	38		
91352	172	94504	166	95918	100	97263	153	98205	39		
91353	172	94518	108	95932	101	97264	160	98206	39		
91354	172	94519	116	95962	100	97265	161	98207	36		
91355	173	94521	108	96053	128	97266	154	98208	36		
92051	181	94522	116	96054	129	97267	154	98209	37		
94041	106	94523	149	96055	129	97268	162	98212	41		
94043	110	94524	157	96056	129	97269	162	98213	67		
94045	114	94525	149	96058	164	97271	152	98214	67		
94046	118	94526	157	96059	165	97272	153	98215	67		
94047	106	94527	149	96151	49	97273	160	98238	94		
94048	124	94528	157	96152	48	97274	161	98239	94		
94051	110	94535	148	96153	48	97275	154	98241	94		
94053	114	94536	150	96154	48	97276	155	98242	95		

All previous catalogues and price lists are no longer valid with the issue of this catalogue. Errors, misprints, model and price changes and technical modifications are reserved. We deliver based on our terms of delivery and payment. Our products comply with the European light norm EN60598. Products with the ENEC test mark are conforming to the guide line 2006/95/EG. Products with additional safety remarks (e.g protection class, IP) are identified within the product family with the relevant symbol and number. The content of this catalogue is protected under copyright law for EGLO Leuchten GmbH. All rights reserved. Our specific written consent must be obtained before using any illustrations and texts. The pictures are 4C prints and may differ from the original.

The product pictures and ambiances in this catalogue can deviate from reality, and they do not necessarily concur with the usual application of the product. EGLO does not assume liability for the correctness, completeness or the application depiction of the products and/or the product information.

Design, layout and composition: EGLO GmbH, A-6136 Pill - AUSTRIA

Print: Johann Sandler GesmbH & Co KG, 3671 Marbach

Pictures: EGLO, Adobe Stock, iStockphoto

Mit diesem Katalog verlieren alle vorhergehenden Kataloge und Preislisten ihre Gültigkeit. Irrtümer, Druckfehler, Modell- und Preisänderungen sowie technische Änderungen vorbehalten. Wir liefern zu unseren Liefer- und Zahlungsbedingungen. Unsere Produkte entsprechen der europäischen Leuchtnorm EN 60598. Produkte mit dem ENEC Prüfzeichen sind konform mit der Richtlinie 2006/95/EG. Produkte mit weiteren Sicherheitshinweisen (zB. Schutzklasse, IP) sind mit Symbol und Zahl bei der Produktfamilie ausgezeichnet. Der Inhalt dieses Kataloges ist für die EGLO Leuchten GmbH urheberrechtlich geschützt. Alle Rechte sind vorbehalten. Bilder und Texte dürfen nicht ohne vorherige ausdrückliche, schriftliche Genehmigung verwendet werden. Die Abbildungen sind 4C Drucke und können vom Original abweichen.

Die Katalogbilder und die gezeigten Darstellungen der Produkte können von der Wirklichkeit abweichen und nicht den üblichen Produktanwendungen entsprechen. EGLO übernimmt keine Haftung für die Richtigkeit, Vollständigkeit und Anwendungsdarstellung der Produkte und Produktinformationen.

Gestaltung, Layout und Satz: EGLO GmbH, A-6136 Pill - AUSTRIA

Druck: Johann Sandler GesmbH & Co KG, 3671 Marbach

Bilder: EGLO, Adobe Stock, iStockphoto

Le présent catalogue remplace tous les catalogues et tarifs précédents. Sous réserve d'erreurs, de fautes d'impression, de modification des modèles et de changement de prix et de technique. Nous livrons sur la base de nos conditions de livraison et de paiement. Nos produits sont conformes aux normes européennes EN 60598 et portent le marquage CE. Les produits portant la marque ENEC sont conformes à la Directive 2006/95/EG. Les produits portant d'autres indications de sécurité (par exemple classe de protection, IP) sont identifiés par le symbole et le nombre correspondants dans la famille de produits.

Le contenu du présent catalogue est protégé pour la société EGLO Leuchten GmbH par un copyright. Tous droits réservés. Toute reproduction d'images et de texte est interdite sans autorisation explicite par écrit préalable. Les images sont imprimées en 4C et peuvent différer de l'original.

Les images des produits et les ambiances dans le catalogue peuvent dévier de la réalité et ne sont pas nécessairement en ligne avec l'usage habituel du produit. EGLO n'engage pas sa responsabilité sur la justesse des images et sur les informations relatives à l'usage pouvant être fait des produits.

Conception, maquette et composition: EGLO GmbH, A-6136 Pill - AUSTRIA

Presse: Johann Sandler GesmbH & Co KG, 3671 Marbach

Images: EGLO, Adobe Stock, iStockphoto

06-2019

Поставщик EGLO в
Украине

 **ElectroTorg**

electrotorg.biz.ua



EGLO
my light | my style

EGLO Leuchten GmbH
Heiligkreuz 22
A-6136 Pill
Austria
Tel. +43 (0) 5242 6996
Fax +43 (0) 5242 6996-972
info@eglo.com
www.eglo.com

KATLS19

Поставщик EGLO в
Украине

 **ElectroTorg**

electrotorg.biz.ua

my light | my style